



**Model 691C41**

**Vibration Switch Box**

**Installation and Operating Manual**

**For assistance with the operation of this product,  
contact the PCB Piezotronics, Inc.**

**Toll-free: 800-959-4464**

**24-hour SensorLine: 716-684-0001**

**Fax: 716-684-3823**

**E-mail: [imi@pcb.com](mailto:imi@pcb.com)**

**Web: [www.imi-sensors.com](http://www.imi-sensors.com)**



## Repair and Maintenance

PCB guarantees Total Customer Satisfaction through its “Lifetime Warranty Plus” on all Platinum Stock Products sold by PCB and through its limited warranties on all other PCB Stock, Standard and Special products. Due to the sophisticated nature of our sensors and associated instrumentation, **field servicing and repair is not recommended and, if attempted, will void the factory warranty.**

Beyond routine calibration and battery replacements where applicable, our products require no user maintenance. Clean electrical connectors, housings, and mounting surfaces with solutions and techniques that will not harm the material of construction. Observe caution when using liquids near devices that are not hermetically sealed. Such devices should only be wiped with a dampened cloth—never saturated or submerged.

In the event that equipment becomes damaged or ceases to operate, our Application Engineers are here to support your troubleshooting efforts 24 hours a day, 7 days a week. Call or email with model and serial number as well as a brief description of the problem.

## Calibration

Routine calibration of sensors and associated instrumentation is necessary to maintain measurement accuracy. We recommend calibrating on an annual basis, after exposure to any extreme environmental influence, or prior to any critical test.

PCB Piezotronics is an ISO-9001 certified company whose calibration services are accredited by A2LA to ISO/IEC 17025, with full traceability to SI through N.I.S.T. In addition to our standard calibration services, we also offer specialized tests, including: sensitivity at elevated or cryogenic temperatures, phase response, extended high or low frequency response, extended range, leak testing, hydrostatic pressure testing, and others. For more information, contact your local PCB Piezotronics distributor, sales representative, or factory customer service representative.

## Returning Equipment

If factory repair is required, our representatives will provide you with a Return Material Authorization (RMA) number, which we use to reference any information you have already provided and expedite the repair process. This number should be clearly marked on the outside of all returned package(s) and on any packing list(s) accompanying the shipment.

## Contact Information

PCB Piezotronics, Inc.  
3425 Walden Ave.  
Depew, NY14043 USA  
Toll-free: (800) 828-8840  
24-hour SensorLine: (716) 684-0001  
General inquiries: [info@pcb.com](mailto:info@pcb.com)  
Repair inquiries: [rma@pcb.com](mailto:rma@pcb.com)

For a complete list of distributors, global offices and sales representatives, visit our website, [www.pcb.com](http://www.pcb.com).

## Safety Considerations

This product is intended for use by qualified personnel who recognize shock hazards and are familiar with the precautions required to avoid injury. While our equipment is designed with user safety in mind, the protection provided by the equipment may be impaired if equipment is used in a manner not specified by this manual.

Discontinue use and contact our 24-Hour Sensorline if:

- Assistance is needed to safely operate equipment
- Damage is visible or suspected
- Equipment fails or malfunctions

For complete equipment ratings, refer to the enclosed specification sheet for your product.

## Definition of Terms and Symbols

The following symbols may be used in this manual:



### DANGER

Indicates an immediate hazardous situation, which, if not avoided, may result in death or serious injury.

**CAUTION**

Refers to hazards that could damage the instrument.

**NOTE**

Indicates tips, recommendations and important information. The notes simplify processes and contain additional information on particular operating steps.

**The following symbols may be found on the equipment described in this manual:**



This symbol on the unit indicates that high voltage may be present. Use standard safety precautions to avoid personal contact with this voltage.



This symbol on the unit indicates that the user should refer to the operating instructions located in the manual.



This symbol indicates safety, earth ground.



PCB工业监视和测量设备 - 中国RoHS2公布表

PCB Industrial Monitoring and Measuring Equipment - China RoHS 2 Disclosure Table

部件名称	有害物质					
	铅 (Pb)	汞 (Hg)	镉 (Cd)	六价铬 (Cr(VI))	多溴联苯 (PBB)	多溴二苯醚 (PBDE)
住房	0	0	0	0	0	0
PCB板	X	0	0	0	0	0
电气连接器	0	0	0	0	0	0
压电晶体	X	0	0	0	0	0
环氧	0	0	0	0	0	0
铁氟龙	0	0	0	0	0	0
电子	0	0	0	0	0	0
厚膜基板	0	0	X	0	0	0
电线	0	0	0	0	0	0
电缆	X	0	0	0	0	0
塑料	0	0	0	0	0	0
焊接	X	0	0	0	0	0
铜合金/黄铜	X	0	0	0	0	0
本表格依据 SJ/T 11364 的规定编制。						
0：表示该有害物质在该部件所有均质材料中的含量均在 GB/T 26572 规定的限量要求以下。						
X：表示该有害物质至少在该部件的某一均质材料中的含量超出 GB/T 26572 规定的限量要求。						
铅是欧洲RoHS指令2011/65/ EU附件三和附件四目前由于允许的豁免。						

CHINA RoHS COMPLIANCE

Component Name	Hazardous Substances					
	Lead (Pb)	Mercury (Hg)	Cadmium (Cd)	Chromium VI Compounds (Cr(VI))	Polybrominated Biphenyls (PBB)	Polybrominated Diphenyl Ethers (PBDE)
Housing	O	O	O	O	O	O
PCB Board	X	O	O	O	O	O
Electrical Connectors	O	O	O	O	O	O
Piezoelectric Crystals	X	O	O	O	O	O
Epoxy	O	O	O	O	O	O
Teflon	O	O	O	O	O	O
Electronics	O	O	O	O	O	O
Thick Film Substrate	O	O	X	O	O	O
Wires	O	O	O	O	O	O
Cables	X	O	O	O	O	O
Plastic	O	O	O	O	O	O
Solder	X	O	O	O	O	O
Copper Alloy/Brass	X	O	O	O	O	O

This table is prepared in accordance with the provisions of SJ/T 11364.

O: Indicates that said hazardous substance contained in all of the homogeneous materials for this part is below the limit requirement of GB/T 26572.

X: Indicates that said hazardous substance contained in at least one of the homogeneous materials for this part is above the limit requirement of GB/T 26572.

Lead is present due to allowed exemption in Annex III or Annex IV of the European RoHS Directive 2011/65/EU.

## **Models (PS)(SS)691C41(T) & (PS)(SS)691C42(T) Rotary Switch Boxes**

---



### ***Operating Guide with Enclosed Warranty Information***

---

**3425 Walden Avenue, Depew, New York 14043-2495**

**Phone (716) 684-0003**

**Fax (716) 684-3823**

**Toll Free Line 1-800-959-4IMI**

MANUAL NUMBER: 65521  
MANUAL REVISION: NR  
ECO 47778

**Table of Contents**

---

*Introduction*..... Page 3

*Installation* ..... Page 4

*Grounding the Enclosure* ..... Page 4

*Input Wiring* ..... Page 5

*Output Wiring* ..... Page 6

*Using the Enclosure* ..... Page 6

*Calibrating the Enclosure* ..... Page 6

*ESD Warning Information*..... Page 7

**Warranty/Service**

---

*Warranty, Service & Return Procedure* ..... Page 8

*Customer Service*..... Page 9

**Introduction**

Models 691C41 and 691C42 are rotary switch boxes that provide terminal strip inputs for sensor cable termination with the convenience of BNC & military connectors for switched outputs and terminal strips for continuous outputs. They are typically used in conjunction with third-party data collectors and analyzers. The boxes provide simultaneous vibration and temperature inputs on every channel so that they can be used in conjunction to temperature output (TO) sensors (accelerometers with a built-in temperature sensor that provide simultaneous vibration and temperature signals). Specifications and drawings are below for reference:

Model Number	691C41	691C42
Channel Count	6	12
Input Connector	4-socket screw terminal strip per channel	
Continuous Output Connector	4-socket screw terminal strip per channel	
Switched Output Connector Number	3	
Switched Output Connector #1 Type	2-pin MIL connector OR 3-pin MIL connector (T suffix)	
Switched Output Connection #1 Output	Vibration (2-pin) OR Vibration & Temp (T suffix)	
Switched Output Connector #2 Type	BNC Jack	
Switched Output Connector #2 Output	Vibration	
Switched Output Connector #3 Type	BNC Jack	
Switched Output Connector #3 Output	Temperature	
Enclosure Rating	NEMA 4X (IP66)	
Housing Material	Fiberglass Painted Steel (PS prefix) Stainless steel (SS prefix)	
Size (excluding latch & mounting access)	10"H x 8"W x 6"D	

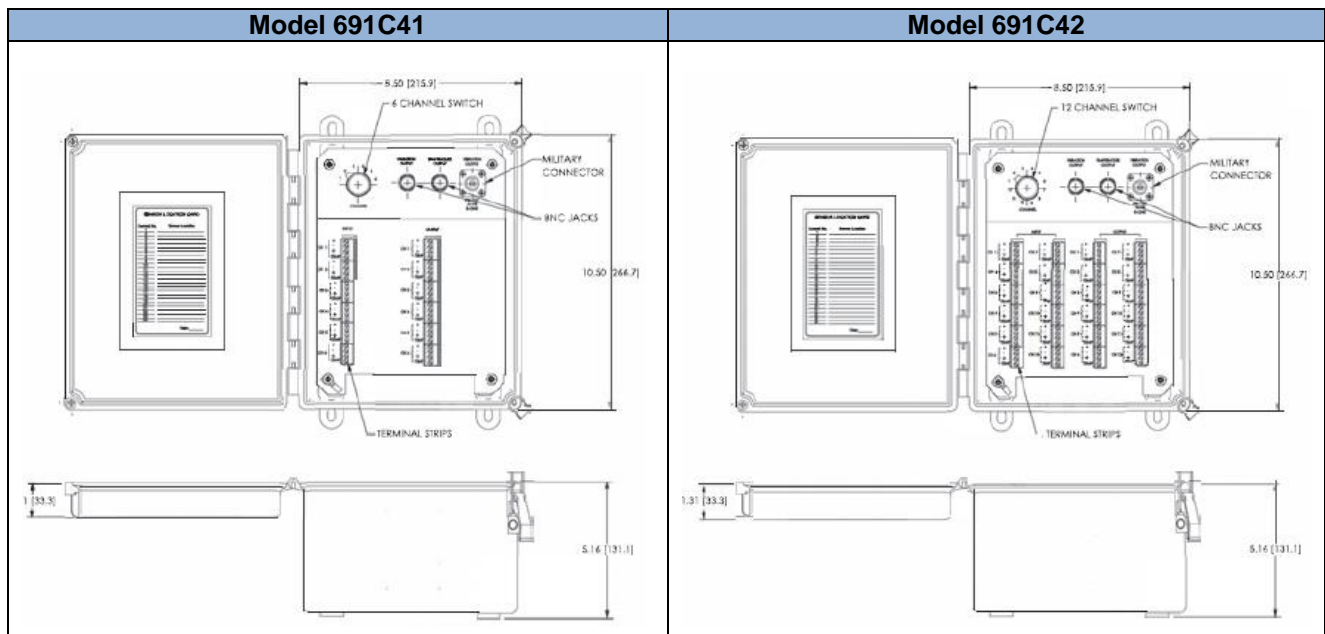



**Installation**

Establish an easily accessible location for installation.

Fiberglass rotary switch boxes include four polyester mounting brackets and four stainless steel attachment screws that are shipped loose to facilitate enclosure mounting. There are positioning indents on the back of the box in each corner. Once the mounting brackets are positioned properly, they should then be fastened to the box with the provided screws. Hardware for fastening the mounting brackets to the installation surface are to be provided in the field.

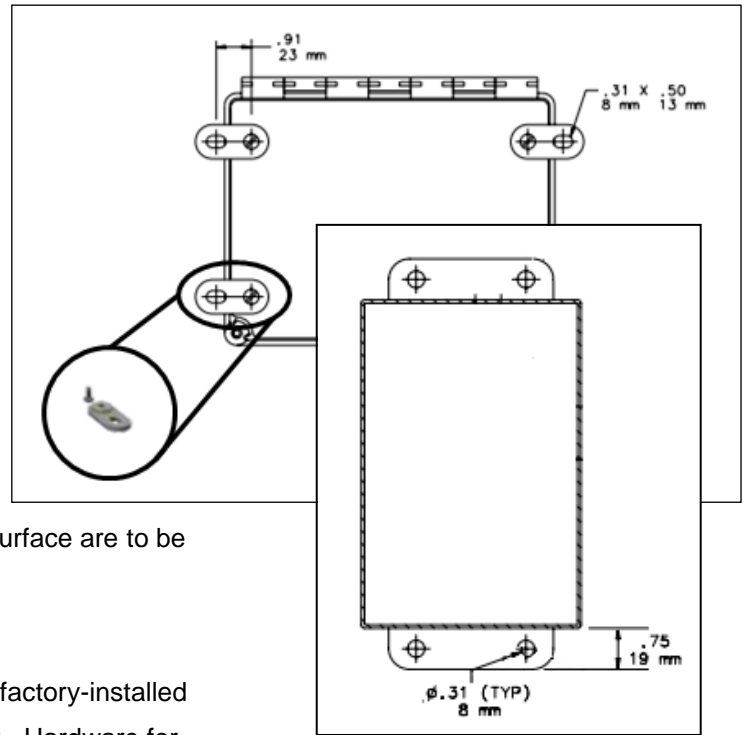

Painted steel and stainless steel boxes include two factory-installed mounting brackets on the top and bottom of the box. Hardware for fastening the mounting brackets to the installation surface are to be provided in the field.

Box may or may not have shipped from factory with factory-installed connection ports. If box did ship from factory with factory-installed connection ports, ensure that box is mounted with connection ports facing down. The factory-installed connection port options are listed in the table below.

	(6) PGME07 Cord Grips	(12) PGME07 Cord Grips	(1) PGME29 Cord Grip	(2) PGME29 Cord Grips	(6) PGME07 Cord Grips & (1) PGME29 Cord Grip	(6) PGME07 Cord Grips & (1) PGME29 Cord Grip	(1) 1.5" Conduit Fitting	(2) 1.5" Conduit Fittings
	/691010	/691020	/691011	/691071	/691004	/691000	/691013	/691026
<b>(PS)(SS)691C41(T)</b>	Yes	Yes	Yes	Yes	Yes	No	Yes	Yes
<b>(PS)(SS)691C42(T)</b>	No	Yes	Yes	Yes	No	Yes	Yes	Yes

If the box did not ship from factory with factory-installed connections ports, drill/punch the necessary holes in the bottom of box for the input and output cabling. Be very careful when drilling/punching holes in the box as to not damage the internal metal, terminal strips and printed circuit boards. Also, take every possible precaution to prevent water entrainment into the box.

**Grounding the Enclosure**

To ground the internal shielding system (ground planes on PC Board, mounting panel and switch enclosure), an external earth ground wire must be connected. To do this, the bottom, right, inner-mounting hole has a double nut included. Unscrew the nut and insert ground wire between the washers and screw nut tightly down again. This will earth ground all the shields and the inner metal pieces. This will not ground the (-) input of the vibration sensors, since they are isolated from the shield.

**Input Wiring**

Sensor cables should be routed through connection ports and then connected to their respective channel's terminal strip per the diagram below. If connection ports are cord grips, cord grips should then be tightened to maintain the enclosure's ingress protection rating.

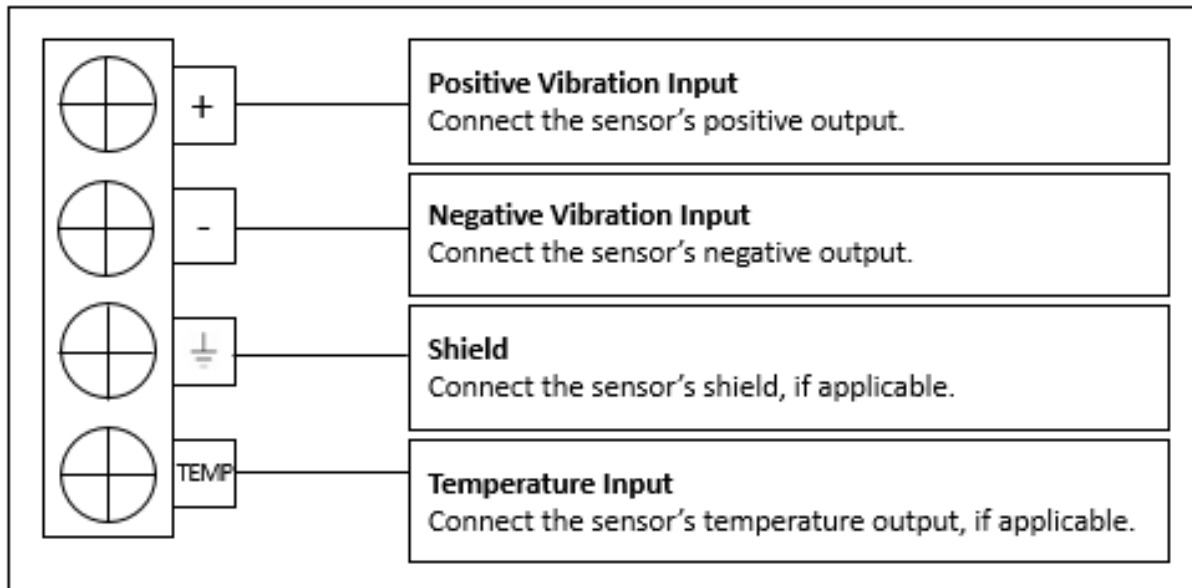

**Output Wiring**

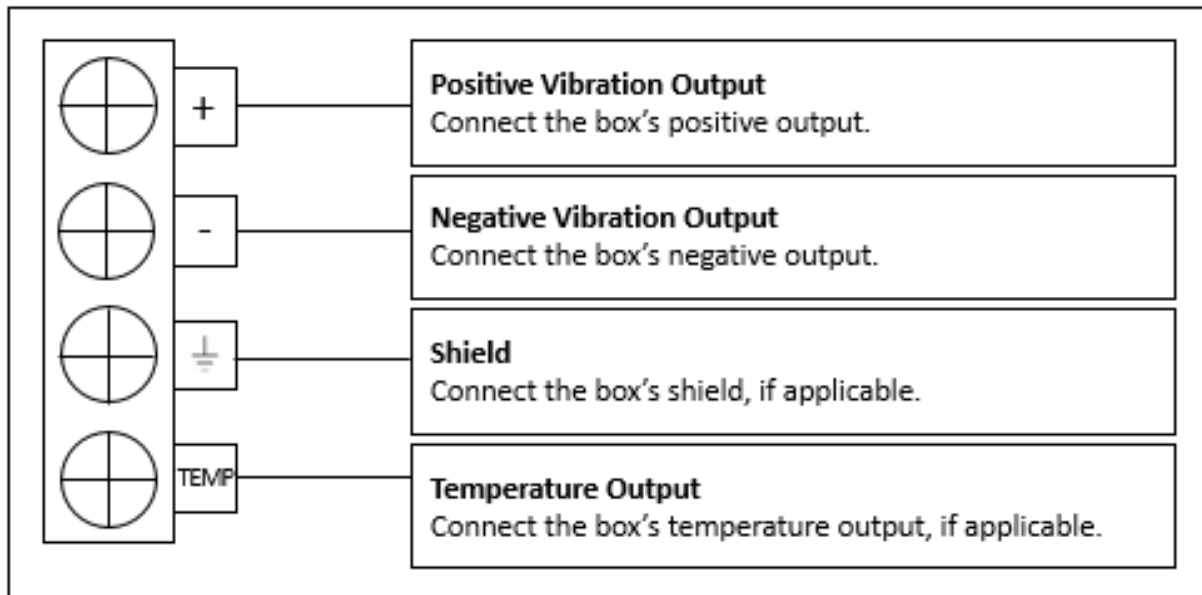

**Using the Enclosure**

When collecting data from the enclosure using the BNC and/or MIL connectors and a data collector, connect the data's collector connector to its appropriate connector mate in the box and modulate the switch to the appropriate channel. If the output terminals are not being used, then the data collector must provide power for the sensor in order to for a signal to be obtained. If the output terminals are being used, then the sensor is already being powered and the data collector does not need to provide power.

**Calibrating the Enclosure**

The models do not require calibration. If there are any questions concerning the products, please contact the factory.

**Warning 1 – ESD Sensitivity**

---

**The power supply/signal conditioner should not be opened by anyone other than qualified service personnel.** This product is intended for use by qualified personnel who recognize shock hazards and are familiar with the safety precautions required to avoid injury.

**Warning 2 – ESD Sensitivity**

---

This equipment is designed with user safety in mind; however, the protection provided by the equipment may be impaired if the equipment is used in a manner not specified by PCB Piezotronics, Inc.

**Caution 1 – ESD Sensitivity**

---

**Cables can kill your equipment.** High voltage electrostatic discharge (ESD) can damage electrical devices. Similar to a capacitor, a cable can hold a charge caused by triboelectric transfer, such as that which occurs in the following:

- *Laying on and moving across a rug,*
- *Any movement through air,*
- *The action of rolling out a cable, and/or*
- *Contact with a non-grounded person.*

**The PCB solution for product safety:**

- *Connect the cables only with the AC power off.*
- *Temporarily “short” the end of the cable before attaching it to any signal input or output.*

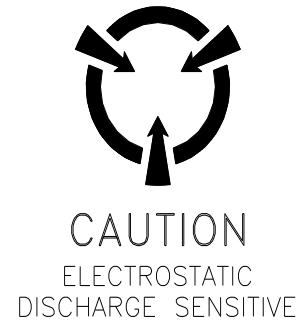
**Caution 2 – ESD Sensitivity**

---

**ESD considerations should be made prior to performing any internal adjustments on the equipment.** Any piece of electronic equipment is vulnerable to ESD when opened for adjustments. Internal adjustments should therefore be done ONLY at an ESD-safe work area. Many products have ESD protection, but the level of protection may be exceeded by extremely high voltage.

### **Warranty**

---

IMI instrumentation is warranted against defective material and workmanship for 1 year unless otherwise expressly specified. Damage to instruments caused by incorrect power or misapplication, is not covered by warranty. *If there are any questions regarding power, intended application, or general usage, please consult with your local sales contact or distributor.* Batteries and other expendable hardware items are not covered by warranty.

### **Service**

---

Because of the sophisticated nature of IMI instrumentation, field repair is typically **NOT** recommended and may void any warranty. If factory service is required, return the instrumentation according to the "Return Procedure" stated below. *A repair and/or replacement quotation will be provided prior to servicing at no charge.* Before returning the unit, please consult a factory IMI applications engineer concerning the situation as certain problems can often be corrected with simple on-site procedures.

### **Return Procedure**

---

*To expedite returned instrumentation, contact a factory IMI applications engineer for a RETURN MATERIAL AUTHORIZATION (RMA) NUMBER.* Please have information available such as model and serial number. Also, to insure efficient service, *provide a written description of the symptoms and problems with the equipment to a local sales representative or distributor, or contact IMI if none are located in your area.*

Customers outside the U.S. should consult their local IMI distributor for information on returning equipment. For exceptions, please contact the International Sales department at IMI to request shipping instructions and an RMA. For assistance, please call (716) 684-0003, or fax us at (716) 684-3823. You may also receive assistance via e-mail at [imi@pcb.com](mailto:imi@pcb.com) or visit our web site at [www.pcb.com](http://www.pcb.com).

### **Customer Service**

---

IMI, a division of PCB Piezotronics, guarantees **Total Customer Satisfaction**. If, at any time, for any reason, you are not completely satisfied with any IMI product, IMI will repair, replace, or exchange it at no charge. You may also choose, within the warranty period, to have your purchase price refunded.

IMI offers to all customers, at no charge, 24-hour phone support. This service makes product or application support available to our customers, day or night, seven days a week. When unforeseen problems or emergency situations arise, call the **IMI Hot Line at (716) 684-0003**, and an application specialist will assist you.



3425 Walden Avenue, Depew, NY 14043-2495  
Phone: (716) 684-0003 • USA Fax: (716) 684-3823 • INTL Fax: (716) 684-4703

**ICP® is a registered trademark of PCB Piezotronics, Incorporated,  
which uniquely identifies PCB sensors that incorporate built-in microelectronics.**

	<u>ENGLISH</u>	<u>SI</u>
<b>Performance</b>		
Channels	6	6
<b>Environmental</b>		
Enclosure Rating	IP66	Nema 4X
<b>Physical</b>		
Electrical Connector(Output, Vibration)	BNC Jack	BNC Jack
Electrical Connector(Output, Temperature)	BNC Jack	BNC Jack
Electrical Connector(Output, Vibration)	2-Pin Mil	2-Pin Mil
Electrical Connector(Input)	Terminal Block	Terminal Block
Electrical Connector(Output, vibration, Temperature)	Terminal Block	Terminal Block
Housing Material	Fiberglass	Fiberglass
Size (Height x Width x Depth)	10 in x 8 in x 6 in	254 mm x 203 mm x 152 mm
Weight	5.0 lb	2.2 kg



*All specifications are at room temperature unless otherwise specified.  
In the interest of constant product improvement, we reserve the right to change specifications without notice.*

<b>OPTIONAL VERSIONS</b>		
Optional versions have identical specifications and accessories as listed for the standard model except where noted below. More than one option may be used.		
<b>691004</b> - 6 Individual PGME07 Cord Grips, 1 Individual PGME29 Cord Grip		
<b>691010</b> - 6 Individual Cord Grips, PGME07		
<b>691011</b> - 1 Individual Cord Grip, PGME29		
<b>691013</b> - 1 Conduit Fitting, 1.5 Inch.		
<b>691020</b> - 12 Individual Cord Grips, PGME07		
<b>691026</b> - 2 Conduit Fittings, 1.5 Inch		
<b>691071</b> - 2 Individual Cord Grips, PGME29		
<b>PS</b> - Painted Steel		
Enclosure Rating	IP65	Nema 12
Weight	7 lb	3.2 kg
Size - Height x Width x Depth	10 in x 8 in x 6 in	254 mm x 203 mm x 152 mm
<b>SS</b> - Stainless Steel Enclosure		
Weight	8.8 lb	4.0 kg
Size - Height x Width x Depth	10 in x 8 in x 4 in	254 mm x 203 mm x 101 mm

**NOTES:**  
[1] See PCB Declaration of Conformance PS152 for details.

**SUPPLIED ACCESSORIES:**  
Model 080A192 4-socket terminal block (1)

Entered: LK	Engineer: RB	Sales: MC	Approved: BAM	Spec Number:
Date: 7/3/2018	Date: 7/3/2018	Date: 7/3/2018	Date: 7/3/2018	<b>64790</b>

<p><b>IMI SENSORS</b> A PCB PIEZOTRONICS DIV. 3425 Walden Avenue, Depew, NY 14043</p>	<p><b>Phone: 800-959-4464</b> <b>Fax: 716-684-3823</b> <b>E-Mail: imi@pcb.com</b></p>
---	---

PCB Piezotronics Inc. claims proprietary rights in the information disclosed hereon. Neither it nor any reproduction thereof will be disclosed to others without the written consent of PCB Piezotronics Inc.

64791

REVISIONS		
REV	DESCRIPTION	DIN
B	UPDATED ARTWORK	49302

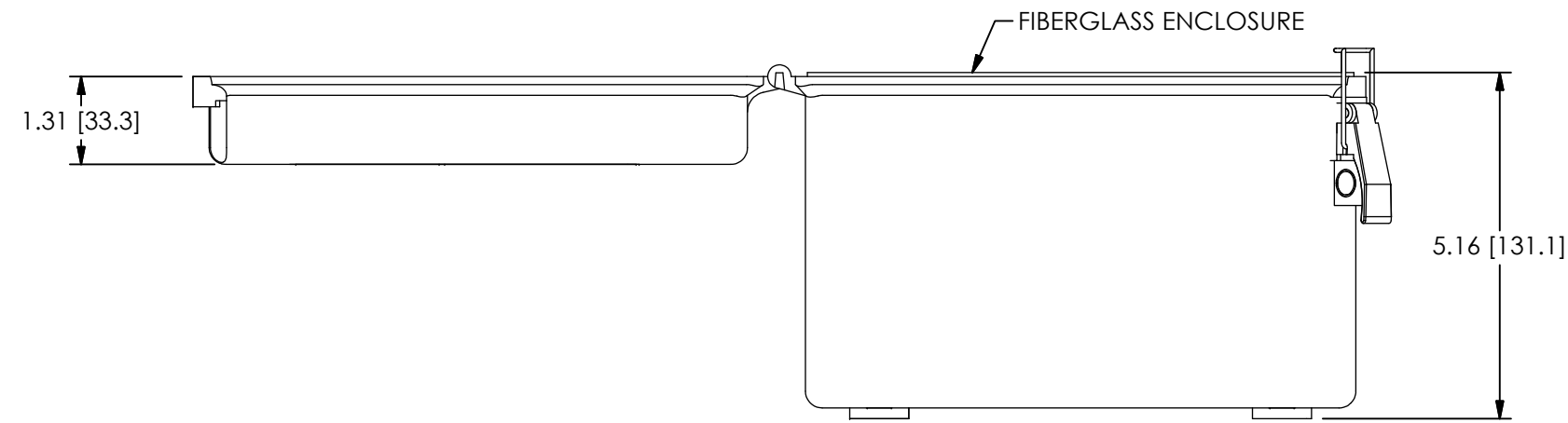
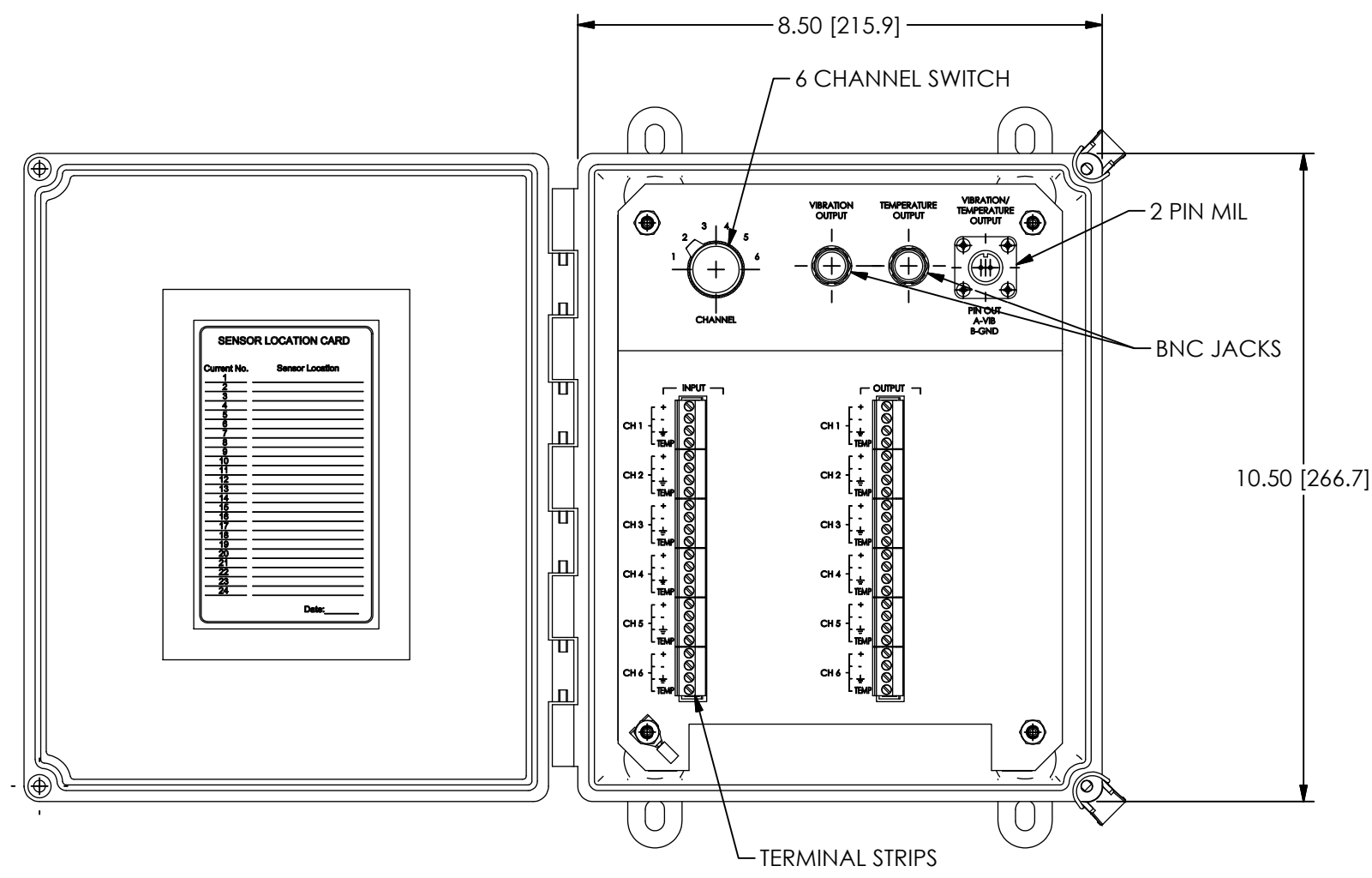

UNLESS OTHERWISE SPECIFIED TOLERANCES ARE:		DRAWN		CHECKED		ENGINEER	
DIMENSIONS IN INCHES	DIMENSIONS IN MILLIMETERS [IN BRACKETS]	JDM	4/11/19	JDM	4/11/19	GGG	4/11/19
DECIMALS XX ±.03 XXX ±.010	DECIMALS X ±0.8 XX ±0.25	TITLE OUTLINE DRAWING MODEL 691C41 6 CHANNEL SWITCH BOX					
ANGLES ± 2 DEGREES	ANGLES ± 2 DEGREES						
FILLETS AND RADII .003 - .005	FILLETS AND RADII 0.07 - 0.13	CODE IDENT. NO. 52681		DWG. NO. 64791		3425 WALDEN AVE. DEPEW, NY 14043 (716) 684-0001 E-MAIL: sales@pcb.com	
		SCALE: .375X		SHEET 1 OF 1			



3425 WALDEN AVE. DEPEW, NY 14043  
(716) 684-0001 E-MAIL: sales@pcb.com

CODE IDENT. NO. 52681  
DWG. NO. 64791

SCALE: .375X SHEET 1 OF 1