



Model EX357A94

Intrinsically-safe charge output accel, 3.3 pC/g, +1200F operation, int hardline cable with 7/16-27 2pin connector)

Installation and Operating Manual

**For assistance with the operation of this product,
contact the PCB Piezotronics, Inc.**

**Toll-free: 716-684-0001
24-hour SensorLine: 716-684-0001
Fax: 716-684-0987
E-mail: info@pcb.com
Web: www.pcb.com**



Repair and Maintenance

PCB guarantees Total Customer Satisfaction through its “Lifetime Warranty Plus” on all Platinum Stock Products sold by PCB and through its limited warranties on all other PCB Stock, Standard and Special products. Due to the sophisticated nature of our sensors and associated instrumentation, **field servicing and repair is not recommended and, if attempted, will void the factory warranty.**

Beyond routine calibration and battery replacements where applicable, our products require no user maintenance. Clean electrical connectors, housings, and mounting surfaces with solutions and techniques that will not harm the material of construction. Observe caution when using liquids near devices that are not hermetically sealed. Such devices should only be wiped with a dampened cloth—never saturated or submerged.

In the event that equipment becomes damaged or ceases to operate, our Application Engineers are here to support your troubleshooting efforts 24 hours a day, 7 days a week. Call or email with model and serial number as well as a brief description of the problem.

Calibration

Routine calibration of sensors and associated instrumentation is necessary to maintain measurement accuracy. We recommend calibrating on an annual basis, after exposure to any extreme environmental influence, or prior to any critical test.

PCB Piezotronics is an ISO-9001 certified company whose calibration services are accredited by A2LA to ISO/IEC 17025, with full traceability to SI through N.I.S.T. In addition to our standard calibration services, we also offer specialized tests, including: sensitivity at elevated or cryogenic temperatures, phase response, extended high or low frequency response, extended range, leak testing, hydrostatic pressure testing, and others. For more information, contact your local PCB Piezotronics distributor, sales representative, or factory customer service representative.

Returning Equipment

If factory repair is required, our representatives will provide you with a Return Material Authorization (RMA) number, which we use to reference any information you have already provided and expedite the repair process. This number should be clearly marked on the outside of all returned package(s) and on any packing list(s) accompanying the shipment.

Contact Information

PCB Piezotronics, Inc.
3425 Walden Ave.
Depew, NY14043 USA
Toll-free: (800) 828-8840
24-hour SensorLine: (716) 684-0001
General inquiries: info@pcb.com
Repair inquiries: rma@pcb.com

For a complete list of distributors, global offices and sales representatives, visit our website, www.pcb.com.

Safety Considerations

This product is intended for use by qualified personnel who recognize shock hazards and are familiar with the precautions required to avoid injury. While our equipment is designed with user safety in mind, the protection provided by the equipment may be impaired if equipment is used in a manner not specified by this manual.

Discontinue use and contact our 24-Hour Sensorline if:

- Assistance is needed to safely operate equipment
- Damage is visible or suspected
- Equipment fails or malfunctions

For complete equipment ratings, refer to the enclosed specification sheet for your product.

Definition of Terms and Symbols

The following symbols may be used in this manual:



DANGER

Indicates an immediate hazardous situation, which, if not avoided, may result in death or serious injury.

**CAUTION**

Refers to hazards that could damage the instrument.

**NOTE**

Indicates tips, recommendations and important information. The notes simplify processes and contain additional information on particular operating steps.

The following symbols may be found on the equipment described in this manual:



This symbol on the unit indicates that high voltage may be present. Use standard safety precautions to avoid personal contact with this voltage.



This symbol on the unit indicates that the user should refer to the operating instructions located in the manual.



This symbol indicates safety, earth ground.



PCB工业监视和测量设备 - 中国RoHS2公布表

PCB Industrial Monitoring and Measuring Equipment - China RoHS 2 Disclosure Table

部件名称	有害物质					
	铅 (Pb)	汞 (Hg)	镉 (Cd)	六价铬 (Cr(VI))	多溴联苯 (PBB)	多溴二苯醚 (PBDE)
住房	0	0	0	0	0	0
PCB板	X	0	0	0	0	0
电气连接器	0	0	0	0	0	0
压电晶体	X	0	0	0	0	0
环氧	0	0	0	0	0	0
铁氟龙	0	0	0	0	0	0
电子	0	0	0	0	0	0
厚膜基板	0	0	X	0	0	0
电线	0	0	0	0	0	0
电缆	X	0	0	0	0	0
塑料	0	0	0	0	0	0
焊接	X	0	0	0	0	0
铜合金/黄铜	X	0	0	0	0	0
本表格依据 SJ/T 11364 的规定编制。						
0：表示该有害物质在该部件所有均质材料中的含量均在 GB/T 26572 规定的限量要求以下。						
X：表示该有害物质至少在该部件的某一均质材料中的含量超出 GB/T 26572 规定的限量要求。						
铅是欧洲RoHS指令2011/65/ EU附件三和附件四目前由于允许的豁免。						

CHINA RoHS COMPLIANCE

Component Name	Hazardous Substances					
	Lead (Pb)	Mercury (Hg)	Cadmium (Cd)	Chromium VI Compounds (Cr(VI))	Polybrominated Biphenyls (PBB)	Polybrominated Diphenyl Ethers (PBDE)
Housing	O	O	O	O	O	O
PCB Board	X	O	O	O	O	O
Electrical Connectors	O	O	O	O	O	O
Piezoelectric Crystals	X	O	O	O	O	O
Epoxy	O	O	O	O	O	O
Teflon	O	O	O	O	O	O
Electronics	O	O	O	O	O	O
Thick Film Substrate	O	O	X	O	O	O
Wires	O	O	O	O	O	O
Cables	X	O	O	O	O	O
Plastic	O	O	O	O	O	O
Solder	X	O	O	O	O	O
Copper Alloy/Brass	X	O	O	O	O	O

This table is prepared in accordance with the provisions of SJ/T 11364.

O: Indicates that said hazardous substance contained in all of the homogeneous materials for this part is below the limit requirement of GB/T 26572.

X: Indicates that said hazardous substance contained in at least one of the homogeneous materials for this part is above the limit requirement of GB/T 26572.

Lead is present due to allowed exemption in Annex III or Annex IV of the European RoHS Directive 2011/65/EU.

General OPERATING GUIDE

for use with

PIEZOELECTRIC CHARGE MODE ACCELEROMETERS

SPECIFICATION SHEET, INSTALLATION DRAWING AND CALIBRATION INFORMATION ENCLOSED

PCB ASSUMES NO RESPONSIBILITY FOR DAMAGE CAUSED TO THIS PRODUCT AS A RESULT OF PROCEDURES THAT ARE INCONSISTENT WITH THIS OPERATING GUIDE.

1.0 INTRODUCTION

Congratulations on the purchase of a quality PCB charge mode accelerometer. In order to ensure the highest level of performance for this product, it is imperative that you properly familiarize yourself with the correct mounting and installation techniques before attempting to operate this device. If, after reading this manual, you have any additional questions concerning this sensor or its application, feel free to call an Application Engineer at 716-684-0001 or the closest PCB representative.

2.0 CHARGE MODE ACCELEROMETERS

Ceramic and UHT 12 shear-structured accelerometers offer high performance for precision vibration measurements in high-temperature environments. The use of sensing crystals, operating in the shear mode, reduces erroneous output due to base strain, thermal transients, and transverse motion.

Charge mode accelerometers output a strong, high-impedance charge signal directly from their sensing element. They do not contain built-in signal conditioning electronics; the signal is conditioned externally by either a laboratory-style charge amplifier or in-line charge converter prior to being analyzed by a readout or recording device. The absence of built-in electronics permits operation to elevated temperatures of 500 °F (260 °C) for most ceramic crystal models and typically 900 °F (482 °C) and extreme application up to 1200 °F (650 °C) for UHT-12.

These accelerometers are ideal for structural testing, machine monitoring, and vehicular shock and vibration measurement tasks where high temperatures preclude the use of accelerometers with built-in microelectronics.

Enclosed is a **Specification Sheet**, which lists the complete performance characteristics of the particular accelerometer.

3.0 OPTIONAL FEATURES

In addition to these standard features, a variety of options are also available. When listed before the model number, the following prefix letters indicate that the sensor is manufactured or supplied with optional features: *A* option- adhesive mount; *J* option- electrical ground isolation; *M* option- metric mounting thread; *P* option- positive polarity output (for use with non-inverting, signal conditioning amplifiers); and *W* option- water-resistant cable connection.

4.0 INSTALLATION OVERVIEW

When choosing a mounting method, consider closely both the advantages and disadvantages of each technique. Characteristics like location, ruggedness, amplitude range, accessibility, temperature, and portability are extremely critical. However, the most important and often overlooked consideration is the effect the mounting technique has on the high-frequency performance of the accelerometer.

Shown hereafter are six possible mounting techniques and their effects on the performance of a typical piezoelectric accelerometer. (Note that not all of the mounting methods may apply to your particular sensor.) The mounting configurations and corresponding graph demonstrate how the high-frequency response of the accelerometer may be compromised as mass is added to the system and/or the mounting stiffness is reduced.

Note: *The low-frequency response is unaffected by the mounting technique. Its roll-off behavior is dependent*

upon the coupling type or time constant of the external charge amplifying device. This characteristic may be fixed or adjustable, depending on the charge amplifier. Please refer to the appropriate charge amplifier specification sheet for information on low-frequency characteristics.

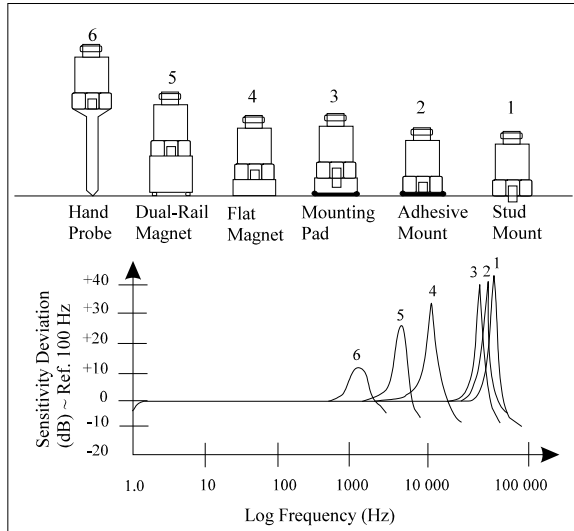

Figure 1. Assorted Mounting Configurations and Their Effects on High Frequency

4.1 STUD MOUNT

This mounting technique requires smooth, flat contact surfaces for proper operation and is recommended for permanent and/or secure installations. Stud mounting is also recommended when testing at high frequencies.

Note: Do NOT attempt mounting on curved, rough, or uneven surfaces, as the potential for misalignment and limited contact surface may significantly reduce the sensor's upper operating frequency range.

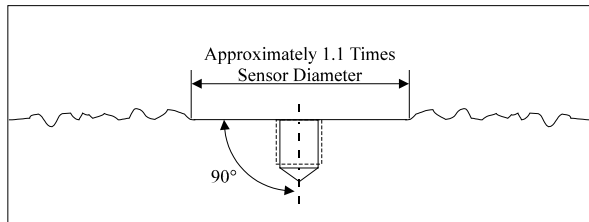

Figure 2. Mounting Surface Preparation

STEP 1: First, prepare a smooth, flat mounting surface, then drill and tap a mounting hole in the center of this area as shown in Figure 2 and in accordance with the **Installation Drawing** for the specific sensor that is being mounted.

A precision-machined mounting surface with a minimum finish of 63 μin (0.00016 mm) is recommended. (If it is not possible to properly prepare the test structure mounting surface, consider adhesive mounting as a possible alternative.) Inspect the area, checking that there are no burrs or other foreign particles interfering with the contact surface.

STEP 2: Wipe clean the mounting surface and spread on a light film of grease, oil, or similar coupling fluid prior to installation.



Figure 3. Mounting Surface Lubrication

Adding a coupling fluid improves vibration transmissibility by filling small voids in the mounting surface and increasing the mounting stiffness. For semi-permanent mounting, substitute epoxy or another type of adhesive.

STEP 3: Screw the mounting stud into the base of the accelerometer and hand-tighten. Then, screw the sensor/stud assembly into the prepared tapped hole and tighten to the recommended mounting torque as indicated on the **Installation Drawing**.

Note: It is important to use a torque wrench during this step. Under-torquing the sensor may not adequately couple the device; over-torquing may result in stud failure.

4.2 ADHESIVE MOUNT

Adhesive mounting is often used for temporary installation or when the test object surface cannot be adequately prepared for stud mounting. Adhesives like hot glue and wax work well for temporary mounts; two-part epoxies and quick-bonding gels provide a more permanent mount.

Note: Adhesively mounted sensors often exhibit a reduction in high-frequency range. Generally, smooth surfaces and stiff adhesives provide the best frequency response.

METHOD 1 - Adhesive Mounting Base

This method involves attaching a base to the test structure, then securing the sensor to the base. This allows for easy removal of the accelerometer. Also, since the bases are of a “hard-coated” aluminum design, they provide electrical isolation to eliminate ground loops and reduce electrical interference that may be present on the surface of the test object.

STEP 1: Prepare a smooth, flat mounting surface. A minimum surface finish of 63 μin (0.00016 mm) generally works best.

STEP 2: Stud-mount the sensor to the appropriate adhesive mounting base according to the guidelines set forth in **STEPS 2** and **3** of the Stud Mount Procedure.

STEP 3: Place a small portion of adhesive on the underside of the mounting base. Firmly press down on the assembly to displace any extra adhesive remaining under the base.

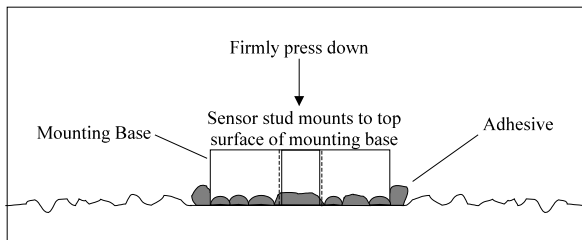

Figure 4. Mounting Base: Adhesive Installation

METHOD 2 - Direct Adhesive Mount

For restrictions of space or for convenience, most sensors (with the exception of integral stud models) can be adhesive-mounted directly to the test structure.

STEP 1: Prepare a smooth, flat mounting surface. A minimum surface finish of 63 μin (0.00016 mm) generally works best.

STEP 2: Place a small portion of adhesive on the underside of the sensor. Firmly press down on the top of the assembly to displace any adhesive. Be aware that excessive amounts of adhesive can make sensor removal difficult.

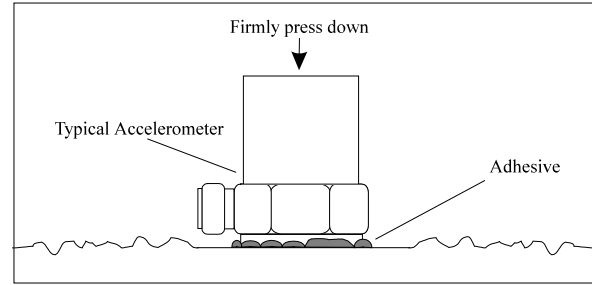

Figure 5. Direct Adhesive Mounting

4.3 HANDHELD OR PROBE TIP MOUNT

This method is NOT recommended for most applications. It is generally used only for machinery monitoring and other portable trending applications. Both the accuracy and repeatability at low (<5 Hz) and high frequency (>1 kHz) ranges are questionable.

5.0 CABLING

Care and attention to installation is essential, as the reliability and accuracy of your system is no better than that of the output cable. Charge mode sensors require the use of low noise cables. Cables and connectors must be kept clean and dry to maintain high insulation resistance. In the event that the insulation resistance is compromised, inspect, clean, and bake cables and connectors to restore insulation resistance.

STEP 1: Ascertain that you have ordered the correct cable type. Use only PCB Series 003 Low-Noise Cable (or equivalent) with charge-output accelerometers. Some integral-cable units use Series 030 Cable, which is also low noise. Keep connections clean to maintain insulation resistance and good low-frequency response.

STEP 2: Connect the cable to the accelerometer. A small amount of thread-locking compound placed on the connector prior to attachment helps secure the cable during testing. In harsh environments, the connection can be sealed with silicone rubber, O-rings, and flexible heat-shrink tubing.

TYPE 1: Coaxial Connectors

First, plug the male connector of the cable into the mating female sensor connector. Then, holding the sensor stationary, secure the connector in place by tightening down the attached cable sleeve.

TYPE 2: Pigtail Connections

“Pigtail” connections are convenient for easy field repair of cable connections. Simply solder the stripped cable to the exposed pins on the sensor. (Check the **Installation Drawing** to determine signal and ground

pins.) In many cases, it is also helpful to protect the solder joint with heat-shrink tubing or epoxy.

Note: *If you do not have the experience or resources to attach pigtail leads, consult PCB to discuss factory attachment. Damage caused by excessive heat is not covered by warranty.*

STEP 3: Route the cable to the signal conditioner, making certain to stress-relieve the sensor/cable connection and minimize motion by clamping the cable at regular intervals.

Certain precautions should be used to avoid physical damage and minimize electrical noise. For instance, avoid routing cables near high-voltage wires. Do not route cables along floors or walkways where they may be stepped on or become contaminated. Shielded cables should have the shield grounded at one end only.

STEP 4: Finally, connect the remaining cable end to the signal conditioner. To dissipate charge that may have accumulated in the cable, short the signal lead to the ground lead prior to attachment.

6.0 POWERING

A conventional method for conditioning the high-impedance signal generated by a charge output sensor is to use a laboratory-style charge amplifier. The charge amplifier converts the high-impedance charge signal generated by the sensor to a low-impedance voltage signal that can then be transmitted to a readout or a recording device for analysis. Before connecting the low-noise cable from the accelerometer to the charge amplifier, be sure to ground both the charge amplifier and the cable. This ensures that an excessive static charge that may have accumulated across the accelerometer or cable is harmlessly discharged. Failure to observe this precaution can result in the destruction of the input FET of certain amplifiers.



Once each element is connected, allow a few minutes for the system to thermally stabilize. Place the switch on the charge amplifier in the OPERATE position and proceed with the measurement.

It is often convenient to normalize the accelerometer and charge amplifier system to a precise sensitivity, such as 10.0 or 100.0 mV/g for ease of data analysis. This is accomplished with most PCB laboratory charge amplifiers and some miniature in-line units as well.

For fixed sensitivity in-line charge converters, such as the PCB Series 422, the system sensitivity (mV/g) is determined as the product of the charge amplifier sensitivity (mV/pC) and the charge sensitivity of the accelerometer (pC/g).

Note: *When using charge-amplified systems, the noise floor of the system is dependent on the input capacitance to the charge amplifier. Since the cable adds to the capacitance and to minimize the noise threshold, keep the cable length between the accelerometer and the charge amplifier to a minimum. Cable length does not affect the system sensitivity of charge-amplified systems.*

Since charge amplifier operation varies, please contact the respective signal conditioner manufacturer or check the product manual for additional information.

7.0 ACCELEROMETER CALIBRATION

Accelerometer calibration provides, with a definable degree of accuracy, the necessary link between the physical quantity being measured and the electrical signal generated by the sensor. In addition, other useful information concerning operational limits, physical parameters, electrical characteristics, or environmental influences may also be determined. Without this link, analyzing data becomes a nearly impossible task. PCB provides a calibration record that documents the exact characteristics of each sensor. (The type and amount of data varies depending on the sensor type, contractual regulations, and other special requirements.)

Under normal operating conditions, piezoelectric sensors are extremely stable, and their calibrated performance characteristics do not change over time. However, harsh environments or other unusual conditions that cause the sensor to experience dynamic phenomena outside of its specified operating range may temporarily or permanently affect the sensor. This change manifests itself in a variety of ways, including a shift of the sensor resonance due to a cracked crystal, or a temporary loss of low-frequency measuring capability due to a drop in insulation resistance.

For these reasons, it is recommended that a recalibration cycle be established for each accelerometer. This schedule is unique and is based on a variety of factors, such as extent of use, environmental conditions, accuracy requirements, trend information obtained from previous calibration records, contractual regulations, frequency of “cross-checking” against other equipment, manufacturer recommendation, and any risk associated with incorrect readings. International standards, such as ISO 10012-1, provide insight and suggested methods for determining recalibration intervals for most measuring equipment. With the above information in mind and under “normal” circumstances, PCB conservatively suggests a 12- to 24-month recalibration cycle for most piezoelectric accelerometers.

Note: *It is good measurement practice to verify the performance of each accelerometer with a Handheld Shaker or other calibration device before and after each measurement. The PCB Model 394C06 Handheld Shaker operates at a fixed frequency and known amplitude (1.0 g) to provide a quick check of sensor sensitivity.*

7.1 SENSOR RECALIBRATION

Accelerometer recalibration services are typically performed by PCB’s internal metrology laboratory. (Other international and private laboratories are also available.) The PCB laboratory is certified to ISO 9001, accredited by A2LA to ISO 17025, complies with ISO 10012-1 (and former MIL-STD-45662A), and uses equipment directly traceable to N.I.S.T. This assures an accurate calibration of relevant specifications.

In addition, many companies choose to purchase the equipment necessary to perform the recalibration procedure themselves. While this may result in both a savings of time and money, it has also been attributed to incorrect readings and costly errors. Therefore, in an effort to prevent the common mistakes associated with customer-performed calibration, this document includes a broad overview of the Back-to-Back Calibration technique. This technique provides a quick and easy method for determining the sensitivity of a test accelerometer over a wide frequency range.

7.2 BACK-TO-BACK CALIBRATION THEORY

Back-to-Back Calibration is perhaps the most common method for determining the sensitivity of piezoelectric accelerometers. This method relies on a simple comparison to a previously calibrated accelerometer, typically referred to as a reference standard.

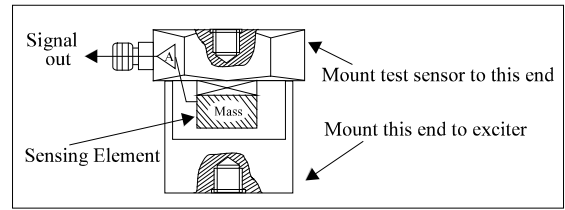

Figure 9. Reference Standard Accelerometer

These high-accuracy devices, which are directly traceable to a recognized standards laboratory, are designed for stability, as well as configured to accept a test accelerometer. By mounting a test accelerometer to the reference standard and then connecting this combination to a suitable vibration source, it is possible to vibrate both devices and compare the data as shown in Figure 10. (Test set-ups may be automated and vary, depending on the type and number of accelerometers being calibrated.)

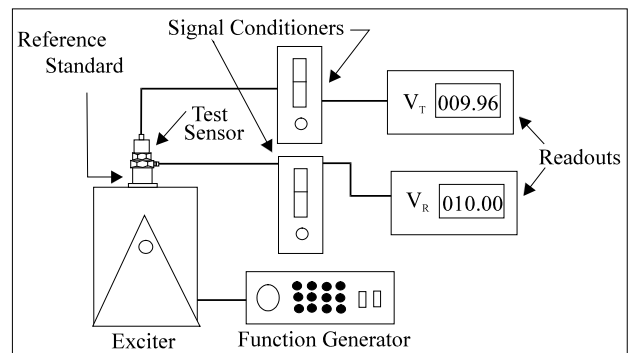

Figure 10. Typical Back-to-Back Calibration System

Because the acceleration is the same on both sensors, the ratio of their outputs (V_T/V_R) must also be the ratio of their sensitivities. With the sensitivity of the reference standard (S_R) known, the exact sensitivity of the test sensor (S_T) is easily calculated by using the following equation:

$$S_T = S_R (V_T/V_R)$$

By varying the frequency of the vibration, the sensor may be calibrated over its entire operating frequency range. The typical response of an unfiltered accelerometer is shown in Figure 11.

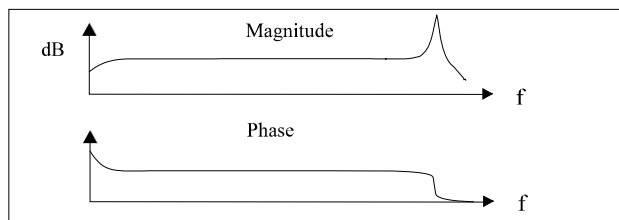

Figure 11. Typical Test Accelerometer Response

7.3 PCB CALIBRATION PROCEDURE

Numerous precautions are taken at PCB to insure accurate and repeatable results. This section provides a brief overview of the primary areas of concern.

Since the Back-to-Back Calibration technique relies on each sensor experiencing an identical acceleration level, proper mounting of the test sensor to the reference standard is imperative. Sensors with mounting holes are attached directly to the reference standard with a stud tightened to the recommended mounting torque. A shouldered mounting stud is typically used to prevent the stud from “bottoming out” in the hole.

Both mounting surfaces are precision-machined and lapped to provide a smooth, flat interface according to the manufacturer’s specification. A thin layer of silicone grease is placed between the mating surfaces to fill any imperfections and increase the mounting stiffness. The cables are stress-relieved by first routing them to the shaker head, securing them with tape or cable ties, then routing them to a nearby stationary location. This reduces cable motion, which is especially important when testing charge output sensors and helps to prevent extraneous noise or stresses from being imparted into the system. A typical set-up is shown in Figure 12.

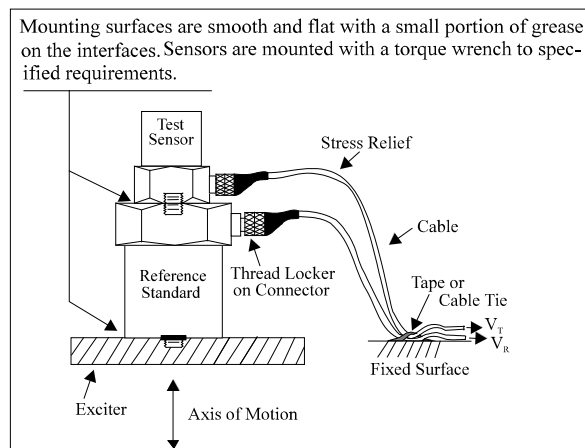

Figure 12. Typical Calibration Set-Up

Adhesively mounted sensors use similar practices. However, in this case, a small portion of quick-bonding gel or similar temporary adhesive is used to attach the test sensor to a reference standard designed with a smooth, flat mounting surface.

In addition to mounting, the selection of the proper equipment is critical. Some of the more important considerations include: 1) the reference standard must be specified and previously calibrated over the frequency and/or amplitude range of interest; 2) the shaker should be selected to provide minimal transverse (lateral) motion and minimal distortion; and 3) the quality of the meters, signal generator, and other devices should be selected so as to operate within the limits of permissible error.

7.4 COMMON MISTAKES

Most calibration errors are caused by simply overlooking some of the fundamental principals of dynamics. This section attempts to address some of the more common concerns.

For stud-mount sensors, always mount the accelerometer directly to the reference standard. Ensure that the mounting surfaces are smooth, flat, and free of any burrs. Always use a coupling fluid, such as silicone grease, in the mounting interface to maintain a high mounting stiffness. Mount the sensor according to the manufacturer’s recommended mounting torque. DO NOT use any intermediate mounting adaptors, as the mounted resonant frequency may be reduced and thereby compromise the high-frequency performance. If necessary, use adaptor studs.



Figure 13. Stud Mounting

For adhesive mount sensors, use a thin, stiff layer of temporary adhesive such as quick-bonding gel or superglue. **DO NOT** use excessive amounts of glue or epoxy, as the mounting stiffness may be reduced and compromise high-frequency performance. It may also damage the sensor during removal.



Figure 14. Incorrect Adhesive Mounting

Triaxial accelerometers should always be mounted directly to the reference standard. Unless absolutely required, **DO NOT** use adaptors to re-orient the sensor

along the axis of motion, as the mounting stiffness may be altered. The vibration at the test sensor sensing element may differ from the vibration at the reference standard due to a “cantilever” effect, seen in Figure 15.



Figure 15. Mounting Triaxial Sensors (Incorrect)

Understand Back-to-Back Calibration limitations. Do not expect the uncertainty of calibration to be any better than $\pm 2\%$. (In fact, the uncertainty may be as high as $\pm 3\%$ or $\pm 4\%$ for frequencies < 10 Hz or > 2 kHz.) Since large sensors may affect high-frequency accuracy, verify that the test sensor does not mass load the reference standard. Validate your calibration system with another accelerometer prior to each calibration session. Check with the manufacturer for exact system specifications.

7.5 CONCLUSIONS

Without an adequate understanding of dynamics, determining what, when, and how to test a sensor is a difficult task. Therefore, each user must weigh the cost, time, and risk associated with self-calibration versus the services of an accredited laboratory.

3425 Walden Avenue, Depew,
Toll Free: 888-684-0013 • 24-



0001 • FAX: 716-685-3886

E-mail: vibration@pcb.com • Website: www.pcb.com

NY 14043
hour SensorLineSM: 716-684-

Model Number
EX357A94

CHARGE OUTPUT ACCELEROMETER

Revision: NR
ECN #: 49949

	ENGLISH	SI	
Performance			
Sensitivity(± 10 %)	3.3 pC/g	0.34 pC/(m/s ²)	
Measurement Range	± 1,000 g pk	± 9,800 m/s ² pk	
Frequency Range (± 5 %)	3 kHz	3 kHz	
Frequency Range (± 1 dB)	5 kHz	5 kHz	
Resonant Frequency	≥ 15 kHz	≥ 15 kHz	
Non-Linearity(per full scale range)	≤ 1.0 %	≤ 1.0 %	
Transverse Sensitivity	≤ 5 %	≤ 5 %	
Environmental			
Overload Limit(Shock)	± 2,000 g pk	± 19,600 m/s ² pk	
Temperature Range(Operating)	-67 to 1,200 °F	-55 to 649 °C	
Temperature Range(Survivable Limit)	-67 to 1,400 °F	-55 to 760 °C	
Temperature Range(Cable Termination)	-67 to 900 °F	-55 to 482 °C	
Temperature Response	See graph	See graph	[1]
Radiation Exposure Limit(Integrated Neutron Flux)	1 E10 N/cm ²	1 E10 N/cm ²	
Radiation Exposure Limit(Integrated Gamma Flux)	1 E8 rad	1 E8 rad	
Electrical			
Capacitance	520 pF	520 pF	[1][2]
Insulation Resistance(@ 1200°F[649°C])	≥ 10 kohm	≥ 10 kohm	
Insulation Resistance(@ 70° F [21°C])	≥ 100 MOhm	≥ 100 MOhm	
Output Polarity	Differential	Differential	
Electrical Isolation	Signal isolated from case	Signal isolated from case	
Physical			
Sensing Element	UHT-12™	UHT-12™	
Sensing Geometry	Shear	Shear	
Housing Material	Nickel Alloy	Nickel Alloy	
Sealing(Sensor Housing)	Hermetic	Hermetic	
Sealing(Connector)	Welded Hermetic	Welded Hermetic	
Size - Height	.56 in	14.2 mm	
Size - Length	.95 in	24.1 mm	
Size - Width	.56 in	14.2 mm	
Weight(without cable)	1.6 oz	45 gm	[1]
Mounting	Through Hole	Through Hole	
Cable Length	10 ft	3.05 m	
Cable Type	Integral Hardline Cable	Integral Hardline Cable	
Cable Termination	7/16-27 2-Pin	7/16-27 2-Pin	

OPTIONAL VERSIONS
Optional versions have identical specifications and accessories as listed for the standard model except where noted below. More than one option may be used.

NOTES:

- [1]Typical.
- [2]Additional cable length will add approx. 50pF/ft.
- [3]See PCB Declaration of Conformance PS199 for details.
- [4]See Model's "Instructions For Use" (IFU) for North American Conformity and Certification Statements.

SUPPLIED ACCESSORIES:

Model 081A116 Mounting Screw, 10-32 UNJF-3Ax 5/8", Inconel 718 (1)
Model ACS-1 NIST traceable frequency response (10 Hz to upper 5% point). (1)

Typical Sensitivity Deviation vs Temperature

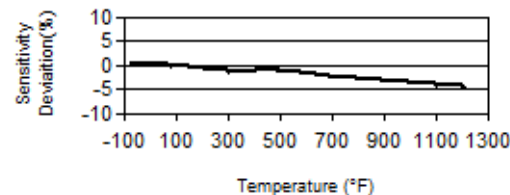

All specifications are at room temperature unless otherwise specified.
In the interest of constant product improvement, we reserve the right to change specifications without notice.

Entered: LK	Engineer: GD	Sales: MC	Approved: BAM	Spec Number:
Date: 10/04/2019	Date: 10/04/2019	Date: 10/04/2019	Date: 10/04/2019	72267



3425 Walden Avenue, Depew, NY 14043

Phone: 716-684-0001
Fax: 716-684-0987
E-Mail: info@pcb.com

67230

PCB Piezotronics Inc. claims proprietary rights in the information disclosed hereon. Neither it nor any reproduction thereof will be disclosed to others without the written consent of PCB Piezotronics Inc.

REVISIONS		
REV	DESCRIPTION	DIN
A	EX357A94 WAS 357A94	49949

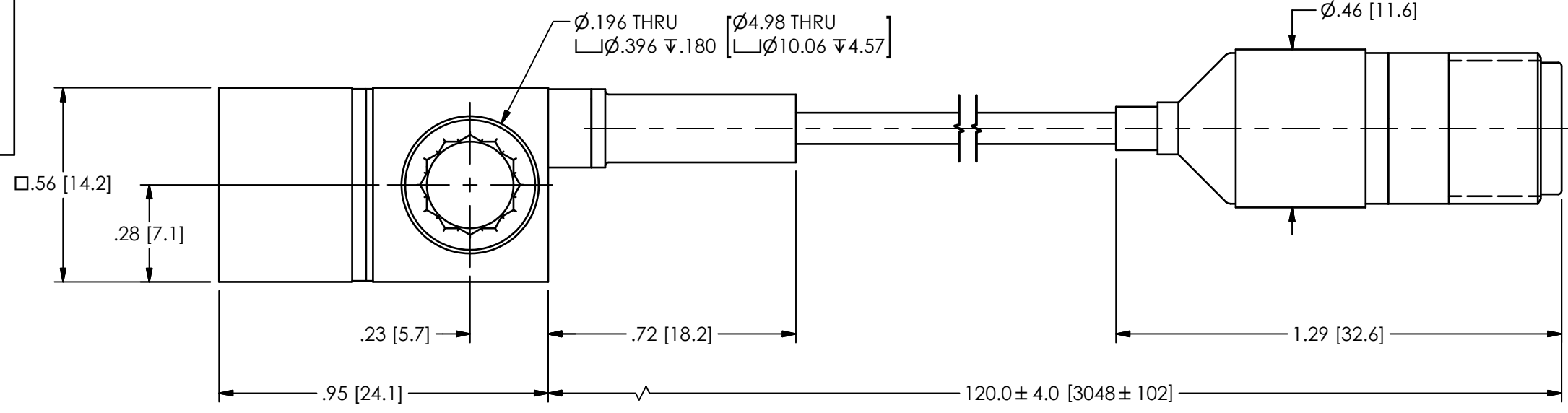

DIRECTION OF ACCELERATION TO PROVIDE A POSITIVE OUTPUT SIGNAL

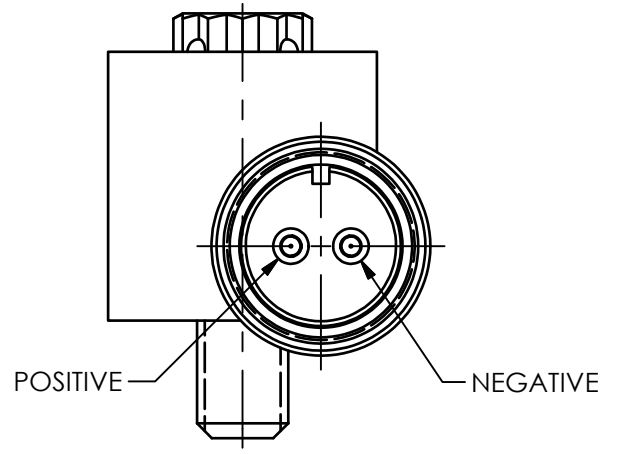
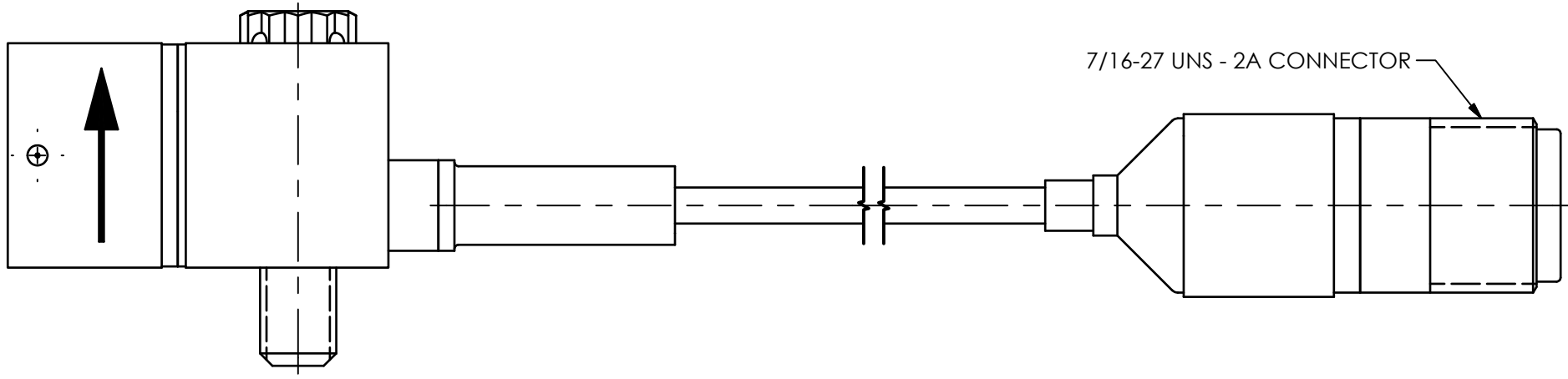

MOUNTING HOLE PREPARATION:
 1 Ø.159 [Ø4.04] ±(X) +.130 [3.30]
 10-32 UNJF-3B ±(X) +.035 [.89]
 WHERE: (X)=DISTANCE MOUNTING SCREW EXTENDS PAST MOUNTING SURFACE [I.E. SCREW INSERTION DEPTH]

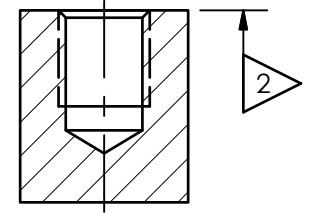

- 5.) CABLE MINIMUM BEND RADIUS: .25 [6.4]
- 4.) RECOMMENDED MOUNTING TORQUE: 10-20 INCH POUNDS [113-225 NEWTON CENTIMETERS]
- 3.) FOR BEST RESULTS, PLACE A THIN LAYER OF SILICONE GREASE (OR EQUIVALENT) ON INTERFACE PRIOR TO MOUNTING
- 2.) MOUNTING SURFACES SHOULD BE FLAT TO WITHIN .001 [.03] TIR ACROSS A 2" DIAMETER AREA WITH A SURFACE FINISH OF 63 [1.61] OR BETTER FOR BEST RESULTS
- 1.) DRILL PERPENDICULAR TO MOUNTING SURFACE TO WITHIN ± 1°

UNLESS OTHERWISE SPECIFIED TOLERANCES ARE:		DRAWN		CHECKED		ENGINEER	
DIMENSIONS IN INCHES	DIMENSIONS IN MILLIMETERS [IN BRACKETS]	JJF	10/1/19	JDM	10/1/19	GCD	10/1/19
DECIMALS XX ±.01 XXX ±.005	DECIMALS X ±.03 XX ±.013	TITLE INSTALLATION DRAWING MODEL EX357A94 ACCELEROMETER					
ANGLES ± 2 DEGREES	ANGLES ± 2 DEGREES						
FILLETS AND RADII .003 - .005	FILLETS AND RADII 0.07 - 0.13	CODE IDENT. NO. 52681		DWG. NO. 67230		SCALE: 2.5X SHEET 1 OF 1	

PCB PIEZOTRONICS™
 3425 WALDEN AVE. DEPEW, NY 14043
 (716) 684-0001 E-MAIL: sales@pcb.com

This authorizes the application of the Certification Mark(s) shown below to the models described in the Product(s) Covered section when made in accordance with the conditions set forth in the Certification Agreement and Listing Report. This authorization also applies to multiple listee model(s) identified on the correlation page of the Listing Report.

This document is the property of Intertek Testing Services and is not transferable. The certification mark(s) may be applied only at the location of the Party Authorized To Apply Mark.

Applicant: PCB Piezotronics, Inc.
Address: 3425 Walden Ave
Depew, NY-14043-2417
Country: USA
Contact: Ms. Carrie Termin
Phone: 716-684-0002 ext. 2206
FAX: NA
Email: ctermin@pcb.com

Manufacturer: PCB Piezotronics, Inc.
Address: 3425 Walden Ave
Depew, NY-14043-2417
Country: USA
Contact: Ms. Carrie Termin
Phone: 716-684-0002 ext. 2206
FAX: NA
Email: ctermin@pcb.com

Party Authorized To Apply Mark: Same as Applicant
Report Issuing Office: Cortland, NY

Control Number: 5010230

Authorized by: 
for Dean Davidson, Certification Manager



This document supersedes all previous Authorizations to Mark for the noted Report Number.

This Authorization to Mark is for the exclusive use of Intertek's Client and is provided pursuant to the Certification agreement between Intertek and its Client. Intertek's responsibility and liability are limited to the terms and conditions of the agreement. Intertek assumes no liability to any party, other than to the Client in accordance with the agreement, for any loss, expense or damage occasioned by the use of this Authorization to Mark. Only the Client is authorized to permit copying or distribution of this Authorization to Mark and then only in its entirety. Use of Intertek's Certification mark is restricted to the conditions laid out in the agreement and in this Authorization to Mark. Any further use of the Intertek name for the sale or advertisement of the tested material, product or service must first be approved in writing by Intertek. Initial Factory Assessments and Follow up Services are for the purpose of assuring appropriate usage of the Certification mark in accordance with the agreement, they are not for the purposes of production quality control and do not relieve the Client of their obligations in this respect.

Intertek Testing Services NA Inc.
545 East Algonquin Road, Arlington Heights, IL 60005
Telephone 800-345-3851 or 847-439-5667 Fax 312-283-1672

	<p>Intrinsically Safe Apparatus And Associated Apparatus For Use In Class 1, 2, 3, Division 1, Hazardous (Classified) Locations [UL 913:2013 Ed.8+R:16Oct2015]</p> <p>Nonincendive Electrical Equipment For Use In Class I And II, Division 2 And Class III, Divisions 1 And 2 Hazardous (Classified) Locations [UL 121201:2017 Ed.9]</p> <p>Explosive Atmospheres – Part 0: Equipment – General Requirements [UL 60079-0:2013 Ed.6+R:20Oct2017]</p> <p>Standard(s): Explosive Atmospheres - Part 11: Equipment Protection By Intrinsic Safety 'i' [UL 60079-11:2013 Ed.6 +R:28Mar2014]</p> <p>Explosive Atmosphere – Part 15: Equipment Protection By Type Of Protection 'N' [UL 60079-15:2013 Ed.4+R:05May2017]</p> <p>Intrinsically Safe And Non-Incendive Equipment For Use In Hazardous Locations (R2016) [CSA C22.2#157:1992 Ed.3+G1;U2]</p> <p>Nonincendive Electrical Equipment For Use In Class I And II, Division 2 And Class III, Divisions 1 And 2 Hazardous (Classified) Locations [CSA C22.2#213:2017 Ed.3]</p>
Product:	<p>High Temperature Vibration Sensors For Use In: Class I, Division 1, Groups A-D Class I, Zone 0, AEx ia IIC T6...770°C Ga Class I, Division 2, Group A, B, C, D Class I, Zone 2, AEX nA IIC T6...770°C Gc -55°C ≤ Tamb ≤ +755°C</p>
Brand Name:	<p>IMI Sensors a Division of PCB Piezotronic, IMI Vibration Sensors</p>
Models:	<p>EX357 followed by one letter; followed by three numbers; may be followed by up to seven characters.</p>

TYPE-EXAMINATION CERTIFICATE

1. Type-examination Certificate (Module A)
2. Equipment or Protective System intended for use in potentially explosive atmospheres (Directive 2014/34/EU)
3. Type examination certificate Nr **ITS19ATEX44455X**



4. **Product:** High Temperature Vibration Sensors (EX357 SERIES)
5. **Manufacturer:** PCB Piezotronics, Incorporated **Applicant:** PCB Piezotronics, Incorporated
6. **Address:** 3425 Walden Avenue, Depew, NY 14043-2495, USA **Address:** 3425 Walden Avenue, Depew, NY 14043-2495, USA

7. This product and any acceptable variation thereto are specified in the schedule to this certificate and therein referred to.
8. INTERTEK ITALIA S.p.A., certifies that the equipment or protective system has been found to comply with the essential Health and Safety Requirements relating to the design and construction of equipment and protective system intended for use in potentially explosive atmosphere, given in Annex II of the Directive.
The examination and tests results are recorded in confidential technical evaluation Intertek Testing and Certification Report Nr. 103645218CRT-003d, 103645218CRT-003e, 103645218CRT-003f; Dated: 2019-01-29.
9. Compliance with the Essential Health and Safety Requirements has been assured by compliance with EN 60079-0:2012+A11:2013 and EN 60079-15:2010 except in respect of those requirements referred to at item 18 of the Schedule
10. If the sign X is placed after the certificate number, it indicates that the product is subject to Special Conditions for Safe Use specified in the schedule to this certificate.
11. This Type Examination Certificate relates only to the design and construction of the specified product. Further requirements of the Directive apply to the manufacturing process and supply of this product. These are not covered by this certificate.
12. The marking of the product shall include the following:



II 3 G Ex nA IIC T6...770°C Gc*
0°C < Tamb < +755°C

Certificate issue date

26 March 2019

Gian Paolo Tondetta
Certification Manager ATEX
Intertek Italia S.p.A. (NB 2575)

This certificate is the transfer of the certificate issued by Intertek Testing & Certification Ltd. having the same number.



This Certificate is for the exclusive use of Intertek's client and is provided pursuant to the agreement between Intertek and its Client. Intertek's responsibility and liability are limited to the terms and conditions of the agreement. Intertek assumes no liability to any party, other than to the Client in accordance with the agreement, for any loss, expense or damage occasioned by the use of this Certificate. Only the Client is authorized to permit copying or distribution of this Certificate and then only in its entirety. Any use of the Intertek name or one of its marks for the sale or advertisement of the tested material, product or service must first be approved in writing by Intertek.

Intertek Italia S.p.A. Via Miglioli, 2/A - 20063 Cernusco sul Naviglio, Milano - Italy



13. SCHEDULE

14. TYPE EXAMINATION CERTIFICATE NUMBER: **ITS19ATEX4445X**

15. DESCRIPTION OF THE EQUIPMENT OR PROTECTIVE SYSTEM

The EX357 Series products are High Temperature Vibration Sensors. There are various Models based on different construction combinations: family type, connector type, cable type, and/or cable length. All models have similar sensing elements: incorporated Piezo element (capacitive) for high temperatures. The vibration sensors provide a charge output when subjected to mechanical motion. The sensors have nickel-based alloy housings.

Models:

EX357XXXX/MNNZZ Series High Temperature Sensor

- Where X: family type (assigned as a letter A to Z)
- YYY: variation type (sequential number that together with the letter X make up the model number).
- MNNZZ: specifies connectors type and cable length - Optional
 - "M": is present only for metric length for integral cable option - Optional
 - "NNN": specifies cable length (32 feet or 10 meters) (three numbers) - Optional
 - "ZZ": specifies connectors type (two letters) - Optional

Temperature classification in function of the operating temperature:

- T6 at ambient + 75°C
- T5 at ambient + 90°C
- T4 at ambient + 125°C
- T3 at ambient + 190°C
- T2 at ambient + 285°C
- T1 at ambient + 435°C
- 770°C at ambient 755°C

16. DRAWINGS AND DOCUMENTS

TITLE	DOCUMENT Nr	LEVEL	DATE
*Technical file intrinsic safety Ex nA	70093	B	25 Jan. 19
*Descriptive notice for the certification of IMI vibration sensors	70098	NR	1/17/19
*Assembly approval EX357XXXX/MNNZZ series high temp sensor	69893	NR	1/25/19
*Approval EX357XXXX/MNNZZ interconnections	69892	NR	1/24/19
*XTAL approval drawing	69894	NR	9/21/18
*Instructions for use – EX357XXXX/MNNZZ	70101	NR	No Date

Copies of the above listed documents are kept at Intertek Italia S.p.A. archive.

17. SPECIAL CONDITIONS FOR SAFE USE

The apparatus must be only connect to an equipment whose electrical parameters are compatible with the electrical parameters. The apparatus shall be connected according to drawing 68438 (page 2/2). The connected cable and the connector must provide a minimum ingress protection of IP54, when assessed according to IEC 60079-0 and IEC 60079-15. Unused connector must be fitted with an appropriately rated blanking cover.



13. SCHEDULE

14. TYPE EXAMINATION CERTIFICATE NUMBER: **ITS19ATEX44455X**

18. **ESSENTIAL HEALTH AND SAFETY REQUIREMENTS**

The relevant essential Health and Safety Requirements have been identified and assessed in Intertek Testing and Certification report nr. 103645218CRT-003d, 103645218CRT-003e, 103645218CRT-003f; Dated: 2019-01-29.

19. **ROUTINE (FACTORY) TESTS**

Dielectric Strength Test Per EN 60079-15

20. **DETAIL OF CERTIFICATE CHANGES**

None.

TYPE EXAMINATION CERTIFICATE

Equipment or Protective System Intended for use in Potentially Explosive Atmospheres Directive
2014/34/EU

1. **Type Examination Certificate Number:** ITS19ATEX44455X Issue 00
2. **Product:** High Temperature Vibration Sensors
(EX357 SERIES)
3. **Manufacturer:** PCB Piezotronics, Incorporated.
4. **Address:** 3425 Walden Avenue, Depew, NY 14043-2495, USA
5. This product and any acceptable variation thereto is specified in the schedule to this certificate and the documents therein referred to.
6. Intertek Testing and Certification Limited, certifies that this product has been found to comply with the Essential Health and Safety Requirements relating to the design and construction of the products intended for use in potentially explosive atmospheres given in Annex II of Directive 2014/34/EU of the European Parliament and of the Council, dated 26 February 2014.
7. Compliance with the Essential Health and Safety Requirements has been assured by compliance with EN 60079-0:2012+A11:2013 and EN 60079-15:2010 except in respect of those requirements referred to within item 14 of the Schedule
8. If the sign "X" is placed after the certificate number, it indicates that the product is subject to the special conditions of use specified in the Schedule to this certificate.
9. This Type Examination Certificate relates only to the design of the specified product and not to specific items subsequently manufactured.
10. The marking of the product shall include the following:



II 3 G Ex nA IIC T6...770°C Gc*
0°C < Tamb < +755°C

Certification Officer: _____

Kevin J. Wolf
Kevin J. Wolf

Date: _____

31 January 2019

SCHEDULE:

TYPE EXAMINATION CERTIFICATE NUMBER ITS19ATEX44455X

11. Description of Equipment or Protective System

The EX357 Series products are High Temperature Vibration Sensors. There are various Models based on different construction combinations: family type, connector type, cable type, and/or cable length. All models have similar sensing elements: incorporated Piezo element (capacitive) for high temperatures. The vibration sensors provide a charge output when subjected to mechanical motion. The sensors have nickel-based alloy housings.

Models:

EX357XYYY/MNNNZZ Series High Temperature Sensor

Where X: family type (assigned as a letter A to Z)

YYY: variation type (sequential number that together with the letter X make up the model number).

MNNNZZ: specifies connectors type and cable length - Optional

“M”: is present only for metric length for integral cable option - Optional

“NNN”: specifies cable length (32 feet or 10 meters) (three numbers) - Optional

“ZZ”: specifies connectors type (two letters) - Optional

Temperature classification in function of the operating temperature:

T6 at ambient + 75°C

T5 at ambient + 90°C

T4 at ambient + 125°C

T3 at ambient + 190°C

T2 at ambient + 285°C

T1 at ambient + 435°C

770°C at ambient 755°C

12. Report Number

Intertek Reports: 103645218CRT-003d, 103645218CRT-003e, 103645218CRT-003f; Dated: 2019-01-31.

13. Conditions of Certification

(a). Special Conditions of Use

1. The apparatus must be only connect to an equipment whose electrical parameters are compatible with the electrical parameters. The apparatus shall be connected according to drawing 68438 (page 2/2). The connected cable and the connector must provide a minimum ingress protection of IP54, when assessed according to IEC 60079-0 and IEC 60079-15. Unused connector must be fitted with an appropriately rated blanking cover.

(b). Conditions of Manufacture - Routine Tests

Dielectric Strength Test Per EN 60079-15

SCHEDULE:

TYPE EXAMINATION CERTIFICATE NUMBER ITS19ATEX44455X

14. Essential Health and Safety Requirements (EHSRs)

The relevant Essential Health and Safety Requirements (EHSRs) affected by this variation have been identified and assessed in Intertek Reports: 103645218CRT-003d, 103645218CRT-003e, 103645218CRT-003f; Dated: 2019-01-31

15. Drawings and Documents

Title:	Drawing No.:	Rev. Level:	Date:
*TECHNICAL FILE INTRINSIC SAFETY Ex nA	70093	B	25 Jan. 19
*DESCRIPTIVE NOTICE FOR THE CERTIFICATION OF IMI VIBRATION SENSORS	70098	NR	1/17/19
*ASSEMBLY APPROVAL EX357XYYY/MNNZZ SERIES HIGH TEMP SENSOR	69893	NR	1/31/19
*APPROVAL EX357XYYY/MNNZZ INTERCONNECTIONS	69892	NR	1/30/19
*XTAL APPROVAL DRAWING	69894	NR	9/21/18
*INSTRUCTIONS FOR USE – EX357XYYY/MNNZZ Accelerometer Series	70101	NR	No Date

EU Declaration of Conformity PS199
In Accordance with ISO/IEC 17050

Manufacturer: PCB Piezotronics, Inc 3425 Walden Avenue Depew, New York 14043 USA	Authorized European Representative: PCB Piezotronics Europe GmbH Porschestrasse 20-30 41836 Hückelhoven, Germany
---	---

Certifies that type of equipment: High Temperature Accelerometer(s)

Whose Product Models Include: EX357A Series, EX357E Series and EX357M Series

This declaration is applicable to all High Temperature Accelerometer(s) of the above series which have the CE & ATEX mark on their data sheets and where those data sheets refer to this declaration of conformity. The data sheets for all model numbers referenced above, which include the CE & ATEX mark on such data sheets and refer to this Declaration of Conformity are hereby incorporated by reference into this Declaration.

Conform to the following EU Directive(s) when installed per product documentation:	2014/34/EU 2011/65/EU w/2015/863/EU	ATEX Directive RoHS Directive
---	--	----------------------------------

Standards to which Conformity is Declared:

Harmonized Standards	EN 60079-0:2012+ A11:2013 EN 60079-11:2012 EN 63000:2018	Explosive atmospheres - Part 0: Equipment - General requirements Explosive atmospheres - Part 11: Equipment protection by intrinsic safety "i" Technical documentation for the assessment of electrical and electronic products with respect to the restriction of hazardous substances
EC Type Examination	ATEX Certification	ITS 19 ATEX 24454 X II 1 G Ex ia IIC T6...770°C Ga
Notified Body Name		Intertek Italia S.p.A. (0359)
Notified Body's Address		Via Miglioli, 2/A 20063 Cernusco sul Naviglio Milano, Italy Tel.: +39 0432 653411 Fax: +39 0432 653499

I, the undersigned, hereby declare that the equipment specified above conforms to the above Directive(s) Standard(s)

Place: Depew, NY **Date:** 07/15/2021

Signature:



Name: Carrie Termin

Title: Regulatory Affairs and Product Certification Specialist



IECEX Certificate of Conformity

INTERNATIONAL ELECTROTECHNICAL COMMISSION IEC Certification System for Explosive Atmospheres

for rules and details of the IECEx Scheme visit www.iecex.com

Certificate No.: **IECEX ETL 19.0002X** Page 1 of 4 [Certificate history:](#)
Status: **Current** Issue No: 0
Date of Issue: 2019-02-04
Applicant: **PCB Piezotronics, Incorporated.**
3425 Walden Avenue, Depew, NY 14043-2495
United States of America
Equipment: **High Temperature Vibration Sensors: EX357 SERIES**
Optional accessory:
Type of Protection: **Intrinsic Safety 'ia'; Type of Protection "nA"**
Marking: Ex ia IIC T6...770°C Ga
Ex nA IIC T6...770°C Ga
IECEX ETL 19.0002X
-55°C ≤ Tamb ≤ +755°C

Approved for issue on behalf of the IECEx
Certification Body:

Kevin J. Wolf

Position:

Certification Officer

Signature:
(for printed version)

Date:
(for printed version)

1. This certificate and schedule may only be reproduced in full.
2. This certificate is not transferable and remains the property of the issuing body.
3. The Status and authenticity of this certificate may be verified by visiting www.iecex.com or use of this QR Code.



Certificate issued by:

Intertek
3933 US Route 11 South
Cortland NY 13045-2995
United States of America

intertek



IECEx Certificate of Conformity

Certificate No.: **IECEx ETL 19.0002X**

Page 2 of 4

Date of issue: 2019-02-04

Issue No: 0

Manufacturer: **PCB Piezotronics, Incorporated.**
3425 Walden Avenue, Depew, NY 14043-2495
United States of America

Manufacturing
locations:

This certificate is issued as verification that a sample(s), representative of production, was assessed and tested and found to comply with the IEC Standard list below and that the manufacturer's quality system, relating to the Ex products covered by this certificate, was assessed and found to comply with the IECEx Quality system requirements. This certificate is granted subject to the conditions as set out in IECEx Scheme Rules, IECEx 02 and Operational Documents as amended

STANDARDS :

The equipment and any acceptable variations to it specified in the schedule of this certificate and the identified documents, was found to comply with the following standards

[IEC 60079-0:2011](#) Explosive atmospheres - Part 0: General requirements
Edition:6.0

[IEC 60079-11:2011](#) Explosive atmospheres - Part 11: Equipment protection by intrinsic safety "i"
Edition:6.0

[IEC 60079-15:2010](#) Explosive atmospheres - Part 15: Equipment protection by type of protection "n"
Edition:4

This Certificate **does not** indicate compliance with safety and performance requirements other than those expressly included in the Standards listed above.

TEST & ASSESSMENT REPORTS:

A sample(s) of the equipment listed has successfully met the examination and test requirements as recorded in:

Test Report:

[US/ETL/ExTR19.0003/00](#)

Quality Assessment Report:

[NL/DEK/QAR14.0004/03](#)



IECEx Certificate of Conformity

Certificate No.: **IECEx ETL 19.0002X**

Page 3 of 4

Date of issue: 2019-02-04

Issue No: 0

EQUIPMENT:

Equipment and systems covered by this Certificate are as follows:

The EX357 Series products are High Temperature Vibration Sensors. There are various Models based on different construction combinations: family type, connector type, cable type, and/or cable length. All models have similar sensing elements: incorporated Piezo element (capacitive) for high temperatures. The vibration sensors provide a charge output when subjected to mechanical motion. The sensors have nickel-based alloy housings.

Models:

EX357XXXX/MNNZZ Series High Temperature Sensor

Where X: family type (assigned as a letter A to Z)

YYY: variation type (sequential number that together with the letter X make up the model number).

MNNZZ: specifies connectors type and cable length - Optional

"M": is present only for metric length for integral cable option - Optional

"NNN": specifies cable length (100 feet or 31 meters) (three

Temperature classification in function of the operating temperature:

T6 at ambient + 75°C

T5 at ambient + 90°C

T4 at ambient + 125°C

T3 at ambient + 190°C

T2 at ambient + 285°C

Ti at ambient + 435°C

770°C at ambient 755°C

SPECIFIC CONDITIONS OF USE: YES as shown below:



IECEx Certificate of Conformity

Certificate No.: **IECEx ETL 19.0002X**

Page 4 of 4

Date of issue: 2019-02-04

Issue No: 0

Ex ia:

The apparatus must only be connected to a certified associated intrinsically safe equipment. This combination must be compatible regarding intrinsic safety rules (see electrical parameters). The apparatus shall be connected according to drawing 69892.

1. The mounting of the apparatus into an installation must be carried out in such a way that metallic body of the accelerometer and cable shield are reliably connected to the system earth.
2. The cable used must have an operating temperature compatible with the environment in which the accelerometer is installed.

Device complies with the requirements of the dielectric test per clause 6.3.13 of standard IEC 60079-11.

Ex nA:

1. The apparatus must be only connect to an equipment whose electrical parameters are compatible with the electrical parameters. The apparatus shall be connected according to drawing 68438 (page 2/2). The connected cable and the connector must provide a minimum ingress protection of IP54, when assessed according to IEC 60079-0 and IEC 60079-15. Unused connector must be fitted with an appropriately rated blanking cover.

Routine tests:

Dielectric Strength Test Per IEC 60079-15

Annex:

[Annex 1 IECEx ETL 19.0002.pdf](#)



IECEX Certificate of Conformity

Certificate No:	IECEX ETL 19.0002X	
Annex No. 1		

Technical Documents			
Title:	Drawing No.:	Rev. Level:	Date:
*TECHNICAL FILE INTRINSIC SAFETY IECEX ia	70094	B	25 Jan. 19
*DESCRIPTIVE NOTICE FOR THE CERTIFICATION OF IMI VIBRATION SENSORS	70099	NR	1/17/19
*ASSEMBLY APPROVAL EX357XXXX/MNNZZ SERIES HIGH TEMP SENSOR	70051	NR	1/31/19
*APPROVAL EX357XXXX/MNNZZ INTERCONNECTIONS	69892	NR	1/30/19
*XTAL APPROVAL DRAWING	69894	NR	9/21/18
*INSTRUCTIONS FOR USE – EX357XXXX/MNNZZ Accelerometer Series	70101	NR	No Date
*TECHNICAL FILE INTRINSIC SAFETY IECEX nA	70095	B	25 Jan. 19
*DESCRIPTIVE NOTICE FOR THE CERTIFICATION OF IMI VIBRATION SENSORS	70100	NR	1/17/19

*Note: An * is included before the title of documents that are new or revised.*

Certificate issued by:

Intertek Testing Services NA Inc.
3933 US Route 11
Cortland NY 13045-2995
United States of America



EU TYPE-EXAMINATION CERTIFICATE

1. EU type-examination Certificate (Module B)
2. Equipment or Protective System intended for use in potentially explosive atmospheres (Directive 2014/34/EU)
3. EU type examination certificate Nr **ITS19ATEX24454X**



4. **Product:** High Temperature Vibration Sensors
(EX357 SERIES)
5. **Manufacturer:** PCB Piezotronics, Incorporated **Applicant:** PCB Piezotronics, Incorporated
6. **Address:** 3425 Walden Avenue, Depew NY 14043-2495, USA **Address:** 3425 Walden Avenue, Depew NY 14043-2495, USA

7. This product and any acceptable variation thereto are specified in the schedule to this certificate and therein referred to.
8. INTERTEK ITALIA S.p.A., Notified Body n° 2575 in accordance with article 17 of the Directive 2014/34/EU of the European Parliament and Council of the 26 February 2014, certifies that the equipment or protective system has been found to comply with the essential Health and Safety Requirements relating to the design and construction of equipment and protective system intended for use in potentially explosive atmosphere, given in Annex II of the Directive.

The examination and tests results are recorded in confidential technical evaluation Intertek Testing and Certification Report Nr. 103645218CRT-002d, 103645218CRT-002e, 103645218CRT-002f; Dated: 2019-01-29.

9. Compliance with the Essential Health and Safety Requirements has been assured by compliance with EN 60079-0:2012+A11:2013, EN 60079-11:2012 except in respect of those requirements referred to at item 18 of the Schedule.
10. If the sign X is placed after the certificate number, it indicates that the product is subject to Special Conditions for Safe Use specified in the schedule to this certificate.
11. This EU-Type Examination Certificate relates only to the design and construction of the specified product. Further requirements of the Directive apply to the manufacturing process and supply of this product. These are not covered by this certificate.
12. The marking of the product shall include the following:



II 1 G Ex ia IIC T6...770°C Ga
0°C < Tamb < +755°C

Certificate issue date

25 March 2019

Gian Paolo Tondetta

Certification Manager ATEX
Intertek Italia S.p.A. (NB 2575)



PDR N° 277B

Membro degli Accordi di Mutuo
Riconoscimento EA, IAF e ILAC

Signatory of EA, IAF and ILAC
Mutual Recognition Agreements

This certificate is the transfer of the certificate issued by Intertek Testing & Certification Ltd. (NB 0359) having the same number.



This Certificate is for the exclusive use of Intertek's client and is provided pursuant to the agreement between Intertek and its Client. Intertek's responsibility and liability are limited to the terms and conditions of the agreement. Intertek assumes no liability to any party, other than to the Client in accordance with the agreement, for any loss, expense or damage occasioned by the use of this Certificate. Only the Client is authorized to permit copying or distribution of this Certificate and then only in its entirety. Any use of the Intertek name or one of its marks for the sale or advertisement of the tested material, product or service must first be approved in writing by Intertek.

Intertek Italia S.p.A. Via Miglioli, 2/A - 20063 Cernusco sul Naviglio, Milano - Italy



13. SCHEDULE

14. EU TYPE EXAMINATION CERTIFICATE NUMBER: **ITS19ATEX24454X**

15. **DESCRIPTION OF THE EQUIPMENT OR PROTECTIVE SYSTEM**

The EX357 Series products are High Temperature Vibration Sensors. There are various Models based on different construction combinations: family type, connector type, cable type, and/or cable length. All models have similar sensing elements: incorporated Piezo element (capacitive) for high temperatures. The vibration sensors provide a charge output when subjected to mechanical motion. The sensors have nickel-based alloy housings.

Models:

EX357XXXX/MNNZZ Series High Temperature Sensor

- Where X: family type (assigned as a letter A to Z)
- YYY: variation type (sequential number that together with the letter X make up the model number).
- MNNZZ: specifies connectors type and cable length - Optional
 - "M": is present only for metric length for integral cable option - Optional
 - "NNN": specifies cable length (32 feet or 10 meters) (three numbers) - Optional
 - "ZZ": specifies connectors type (two letters) - Optional

Temperature classification in function of the operating temperature:

- T6 at ambient + 75°C
- T5 at ambient + 90°C
- T4 at ambient + 125°C
- T3 at ambient + 190°C
- T2 at ambient + 285°C
- T1 at ambient + 435°C
- 770°C at ambient 755°C

CE Marking shall be accompanied by the identification number of the Notified Body responsible for surveillance of production.

16. **DRAWINGS AND DOCUMENTS**

TITLE	DOCUMENT Nr	LEVEL	DATE
Technical File Intrinsic Safety Ex ia	70092	B	25 Jan 19
Descriptive notice for the certification of IMI vibration sensors	70097	NR	1/17/19
Assembly approval EX357XXXX/MNNZZ series High Temp Sensor	69893	NR	1/25/19
*Approval EX357XXXX/MNNZZ Interconnections	69892	NR	1/24/19
*XTAL Approval Drawing	69894	NR	9/21/18
*Instructions for use - EX357XXXX/MNNZZ Accelerometer series	70101	NR	No date

Copies of the above listed documents are kept at Intertek Italia S.p.A. archive.

17. **SPECIAL CONDITIONS FOR SAFE USE**



13. SCHEDULE

14. EU TYPE EXAMINATION CERTIFICATE NUMBER: **ITS19ATEX24454X**

The apparatus must only be connected to a certified associated intrinsically safe equipment. This combination must be compatible regarding intrinsic safety rules (see electrical parameters). The apparatus shall be connected according to drawing 69892.

1. The mounting of the apparatus into an installation must be carried out in such a way that metallic body of the accelerometer and cable shield are reliably connected to the system earth.
2. The cable used must have an operating temperature compatible with the environment in which the accelerometer is installed.

Device complies with the requirements of the dielectric test per clause 6.3.13 of standard IEC 60079-11.

18. ESSENTIAL HEALTH AND SAFETY REQUIREMENTS

The relevant essential Health and Safety Requirements have been identified and assessed in Intertek Testing and Certification Report Nr. 103645218CRT-002d, 103645218CRT-002e, 103645218CRT-002f; Dated: 2019-01-29.

19. ROUTINE (FACTORY) TESTS

None.

20. DETAIL OF CERTIFICATE CHANGES

None.

EU-TYPE EXAMINATION CERTIFICATE

Equipment or Protective System Intended for use in Potentially Explosive Atmospheres Directive
2014/34/EU

1. **EU-Type Examination Certificate Number:** ITS19ATEX24454X **Issue 00**
2. **Product:** High Temperature Vibration Sensors
(EX357 SERIES)
3. **Manufacturer:** PCB Piezotronics, Incorporated.
4. **Address:** 3425 Walden Avenue, Depew, NY 14043-2495, USA
5. This product and any acceptable variation thereto is specified in the schedule to this certificate and the documents therein referred to.
6. Intertek Testing and Certification Limited, Notified Body number 0359 in accordance with Article 17 of Directive 2014/34/EU of the European Parliament and of the Council dated 26 February 2014, certifies that the product has been found to comply with the Essential Health and Safety Requirements relating to the design and construction of products intended for use in potentially explosive atmospheres given in Annex II of the Directive.
7. Compliance with the Essential Health and Safety Requirements has been assured by compliance with EN 60079-0:2012+A11:2013 and EN 60079-11:2012 except in respect of those requirements referred to within item 14 of the Schedule.
8. If the sign "X" is placed after the certificate number, it indicates that the product is subject to the special conditions of use specified in the Schedule to this certificate.
9. This EU-Type Examination Certificate relates only to the design and construction of the specified product. Further requirements of the Directive apply to the manufacturing process and supply of this product. These are not covered by this certificate.
10. The marking of the product shall include the following:



II 1 G Ex ia IIC T6...770°C Ga
0°C < Tamb < +755°C

Certification Officer: _____

Kevin J. Wolf

Kevin J. Wolf

Date: _____

31 January 2019

SCHEDULE:

EU-Type Examination Certificate Number: ITS19ATEX24454X

11. Description of Equipment or Protective System

The EX357 Series products are High Temperature Vibration Sensors. There are various Models based on different construction combinations: family type, connector type, cable type, and/or cable length. All models have similar sensing elements: incorporated Piezo element (capacitive) for high temperatures. The vibration sensors provide a charge output when subjected to mechanical motion. The sensors have nickel-based alloy housings.

Models:

EX357XYYY/MNNZZ Series High Temperature Sensor

Where X: family type (assigned as a letter A to Z)
YYY: variation type (sequential number that together with the letter X make up the model number).
MNNZZ: specifies connectors type and cable length - Optional
“M”: is present only for metric length for integral cable option - Optional
“NNN”: specifies cable length (32 feet or 10 meters) (three numbers) - Optional
“ZZ”: specifies connectors type (two letters) - Optional

Temperature classification in function of the operating temperature:

T6 at ambient + 75°C

T5 at ambient + 90°C

T4 at ambient + 125°C

T3 at ambient + 190°C

T2 at ambient + 285°C

T1 at ambient + 435°C

770°C at ambient 755°C

12. Report Number

Intertek Reports: 103645218CRT-002d, 103645218CRT-002e, 103645218CRT-002f; Dated: 2019-01-31.

SCHEDULE:

EU-Type Examination Certificate Number: ITS19ATEX24454X

13. Special Conditions of Certification

(a). Special Conditions of Use

The apparatus must only be connected to a certified associated intrinsically safe equipment. This combination must be compatible regarding intrinsic safety rules (see electrical parameters). The apparatus shall be connected according to drawing 69892.

1. The mounting of the apparatus into an installation must be carried out in such a way that metallic body of the accelerometer and cable shield are reliably connected to the system earth.
2. The cable used must have an operating temperature compatible with the environment in which the accelerometer is installed.

Device complies with the requirements of the dielectric test per clause 6.3.13 of standard IEC 60079-11.

(b). Conditions of Manufacture - Routine Tests

None

14. Essential Health and Safety Requirements (EHSRs)

The relevant Essential Health and Safety Requirements (EHSRs) have been identified and assessed in Intertek Reports: 103645218CRT-002d, 103645218CRT-002e, 103645218CRT-002f; Dated: 2019-01-31.

15. Drawings and Documents

Title:	Drawing No.:	Rev. Level:	Date:
TECHNICAL FILE INTRINSIC SAFETY Ex ia	70092	B	25 Jan. 19
DESCRIPTIVE NOTICE FOR THE CERTIFICATION OF IMI VIBRATION SENSORS	70097	NR	1/17/19
ASSEMBLY APPROVAL EX357XYYY/MNNZZ SERIES HIGH TEMP SENSOR	69893	NR	1/31/19
*APPROVAL EX357XYYY/MNNZZ INTERCONNECTIONS	69892	NR	1/30/19
*XTAL APPROVAL DRAWING	69894	NR	9/21/18
*INSTRUCTIONS FOR USE – EX357XYYY/MNNZZ Accelerometer Series	70101	NR	No Date